



Development of LoRaWAN-based IoT system for water quality monitoring in rural areas

Waheb A. Jabbar^{a,*}, Tan Mei Ting^b, M. Fikri I. Hamidun^b, Ajwad H. Che Kamarudin^b,
Wenyan Wu^a, Jamil Sultan^{c,d}, AbdulRahman A. Alsewari^e, Mohammed A.H. Ali^f

^a College of Engineering, Faculty of Computing, Engineering and the Built Environment, Birmingham City University, Birmingham B4 7XG, UK

^b Faculty of Electrical and Electronics Engineering Technology, Universiti Malaysia Pahang Al-Sultan Abdullah, 26600 Pekan, Pahang, Malaysia

^c Telecommunication Engineering Technology Department, Sana'a Community College, Sana'a, Yemen

^d Computer Network Engineering Department, University of Modern Sciences, Sana'a, Yemen

^e College of Computing, Faculty of Computing, Engineering and the Built Environment, Birmingham City University, Curzon Street, B4 7XG, Birmingham, UK

^f Department of Mechanical Engineering, Faculty of Engineering, University of Malaya, 50603 Kuala Lumpur, Malaysia

ARTICLE INFO

Keywords:

LoRa
LoRaWAN
Rural Areas
TTN
ThingSpeak
Water Quality Monitoring

ABSTRACT

This article delineates the design and deployment of an innovative real-time water quality monitoring system tailored for rural regions, focusing on monitoring the water resource quality parameters. We propose a solar-powered, waterproof, portable, and Internet of Things (IoT)-enabled solution that leverages Long Range Wide Area Network (LoRaWAN) technology. Central to this system is a sophisticated LoRa node outfitted with an array of sensors for capturing key water parameters, such as pH, total dissolved solids, turbidity and temperature. A conjunction of an Arduino microcontroller-based board and a LoRa shield facilitates real-time data capture and transmission to a LoRaWAN gateway. The acquired data is transmitted to The Things Network server, which is seamlessly integrated with a ThingSpeak web-based IoT server and ThingView mobile applications. We incorporate a solar cell with a solar shield to ensure sustainable energy provision for powering the entire system through a rechargeable battery. This allows users to access vital water quality information online simultaneously and continuously in real-time. As a testament to its robustness, the system was empirically tested at Gambang Lake to demonstrate its effectiveness, functionality, buoyancy, and waterproof capabilities. We further validated the results by comparing them with laboratory sample analysis findings. Experimental evaluations confirmed the system's reliability, as evidenced by the strong agreement between the water conditions measured using our solution and those obtained from laboratory instruments. Moreover, our system efficiently and remotely updated data across multiple IoT platforms using the LoRa radio interface over the LoRaWAN gateway.

1. Introduction

Clean water is an essential resource that is required for life sustainability, and the quality of drinking water plays a major role in the well-being and health of human beings (Cloete et al., 2016; Zhao et al., 2022). However, the water sources available in rural areas for taps at urban houses and water supplies are not always safe to drink. Currently, water quality degradation and pollution problems are ascribed to a variety of sources and cause resulting from urbanization, industry, and over-exploitation of natural resources (Osman et al., 2018). Although it is the responsibility of the water authorities to guarantee that clean water is supplied to its nations, the clean water supply is strained by ageing

infrastructures that are inadequately maintained and continuing population growth (Boccardo et al., 2022). Hence, the water quality must be constantly monitored, and immediate action can be taken to maintain water quality, especially in rural areas.

Water quality may be characterized by its broad composition of water-based properties, which includes physical, chemical, and biological features (parameters) (Caeiro & Martins, 2021; Zhang & Thorburn, 2022). These characteristics are crucial for monitoring water quality because it is used in daily activities, such as drinking, bathing, cooking, and other human tasks, such as agriculture, industrial production, and animal breeding. The parameters of water quality include potential hydrogen (pH), total dissolved solids (TDS), electrical conductivity,

* Corresponding author.

E-mail address: waheb.abdullah@bcu.ac.uk (W.A. Jabbar).

<https://doi.org/10.1016/j.eswa.2023.122862>

Received 24 May 2022; Received in revised form 12 November 2023; Accepted 4 December 2023

Available online 7 December 2023

0957-4174/© 2023 The Author(s). Published by Elsevier Ltd. This is an open access article under the CC BY license (<http://creativecommons.org/licenses/by/4.0/>).

oxidation–reduction potential (ORP), dissolved oxygen (DO), turbidity, and temperature (Ighalo et al., 2020). Water quality monitoring systems are crucial for detecting any changes in the aforementioned quality parameters in real-time to ensure their safety (Shirode et al., 2018).

The Internet of Things (IoT) embodies a dynamic paradigm where interconnected devices, varying in communication capabilities, engage in the exchange and synchronization of data. This network, potentially asymmetrical in nature, facilitates the seamless transfer of information to IoT servers for comprehensive processing and analytics (Kuo et al., 2018; Perumal et al., 2015; Tolentino et al., 2021). IoT-based applications can automatically update the sensor data to the internet in a device-to-device manner without requiring human intervention (Faber et al., 2020). The network infrastructure, particularly in urban areas, is undergoing rapid evolution, thanks in part to advancements in smart city concepts and the Internet of Things. This evolution is characterized by the widespread adoption and integration of established communication standards, network protocols and communication technologies such as ZigBee, Low Power Wide Area Networks (LPWAN), Narrow Band Internet of Things (NB-IoT), Long Range (LoRa), Long Range Wide Area Network (LoRaWAN), and Sigfox. These technologies, already well-defined in the realm of IoT, facilitate varied and efficient connectivity solutions within modern urban environments (Chen & Han, 2018; Premsankar et al., 2020; Singh et al., 2020). Environmental monitoring, including water quality monitoring, is among the emerging applications of IoT. Water quality monitoring and conservation are key utility services that face several problems from the consumer standpoint (Olatinwo & Joubert, 2018). However, the remote sensing assessment of water quality suffers from limited spatial resolution, making it difficult to monitor the quality of freshwaters, such as rivers, channels, and ponds, in urban areas (Chen & Han, 2018). Wireless sensor monitoring of such critical parameters is still considered ineffective and not energy efficient because it does not always fulfil the reasonable needs of certain utilities. Although the existing wireless sensor networks (WSNs) are less expensive than older equipment, certain issues, such as reliability, connectivity, and energy constraints, persist (Abdelfadeel et al., 2019; Cloete et al., 2016). Meanwhile, information handling and management can be improved.

LoRa is a well-known LPWAN technology that exploits a proprietary physical layer (Chirp Spread Spectrum), whereas the upper layers are defined by an open-source standard — LoRaWAN (Sherazi et al., 2020; Magrin et al., 2019; Mroue et al., 2020). LoRa networks have been proposed to connect massive numbers of devices in large areas, and they have attracted increasing attention from the industry and academia to realize IoT implementation (Błażkiewicz et al., 2019; Reynders et al., 2018). LoRaWAN networks are preferred for high-density deployments with flexible restrictions of latency and reliability. After a comprehensive investigation, LoRa and LoRaWAN as its network counterpart were nominated as potential LPWAN candidates for smart sensing technology in environmental monitoring as well as in industrial applications (Afiadi et al., 2019; Jabbar et al., 2022). Hence, LoRa/LoRaWAN composition is selected for water quality monitoring system trials considering several features such as bitrate, energy consumption, communication range, simplicity, unlicensed band, and ease of management owing to its star of stars' topology (Ana et al., 2020; Beltramelli et al., 2020; Chaudhari et al., 2020).

In this work, the LoRa-based sensor node as a physical layer and LoRaWAN-based Gateway as a MAC layer protocol will be utilised to build a cost-effective, energy-efficient, multi-sensor, star topology wireless network for measuring the physicochemical water quality parameters and facultative real-time monitoring. The developed system is known as the water quality monitoring system WQMS-LoRaWAN. Four selected sensors are utilised and connected to a LoRa shield radio interface that is plugged into an Arduino UNO microcontroller-based board to measure the pH, TDS, turbidity, and temperature. The selected sensors enable the internal monitoring of the considered quality parameters of water and send the measured values as a payload stream

based on a preset interval to the gateway that uploads the data to The Things Network (TTN) (over the Internet). The TTN is a proud contributing member of the LoRa Alliance and is dedicated to building the LoRaWAN-based IoT network, which allows devices to connect to the cloud without cellular or Wi-Fi connectivity. The sensing information can be accessed by the user's terminal either via a web-based dashboard over the ThingSpeak platform or ThingView mobile apps using laptops, PCs, or smartphones.

1.1. Motivations and problem statement

Water quality supplied in rural areas is not always safe to use in daily activities. Accordingly, conventional water quality check methods were carried out to monitor the water quality. Such traditional methods focused on manually gathering the water samples and delivering them to the research facility for further testing and inspection are ineffective, not economical, and time-consuming. Traditional water quality methods involve manual water sample collection in various sites and sending analytical techniques to the research facility to assess the character of water quality. These solutions are time-consuming and not economical (Lap et al., 2023). Although existing methods examine the physical, chemical, and biological agents, they still have some drawbacks, such as limited space–time range, time consumption, and cost, which is worker, operation, and apparatus and insufficiency of real-time quality of water info to allow crucial health of the people choose to be made (Feisal et al., 2023). However, constant real-time tracking of the water quality is necessary.

WSNs are widely used for remote sensing and monitoring various stimuli or measuring change phenomena. Sensors in WSNs might need considerable computational power and generate large amounts of information that is transmitted. In rural areas, water quality monitoring networks are expected to have restricted local computation and transmission capabilities because of the nature of communication infrastructure in such areas in addition to limitations of the sensor process capabilities and energy resources (Bhardwaj et al., 2022). The utilization of such technologies is a non-economic and inefficient choice compared with conventional methods. Remote sensing is only suitable for a limited area and is not used in large and rural areas due to its limited communication range, bandwidth, and throughput. Therefore, the utilization of the IoT network is a good solution to overcome the limitations of conventional WSNs.

The IoT architecture supports a wide variety of applications and supplies the required services. Data transmission over the Internet provides better accessibility regardless of time and place. The IoT cloud-based servers allow users to receive data in real-time from various sensors that communicate with each other via wireless radio interfaces. Given the lack of communication infrastructure in rural areas, LoRa is a promising candidate to build a free, long-range, and low-power wireless network for environmental monitoring. Such networks make IoT-based applications convenient for sensing and object detection (Almuhaya et al., 2022). Several parameters need to be considered when designing IoT-based monitoring systems to fulfil the system specifications. These parameters include the cost of materials, energy sustainability, reliability of data transmission, time delay, network coverage, and sensor accuracy (Jabbar et al., 2022).

2. Research contributions

The proposed LoRaWAN system attempts to tackle the aforementioned issues to efficiently measure and track the water quality parameters in rural areas. In this paper, we present several significant advancements in the field of water quality monitoring systems, specifically addressing the limitations of existing solutions through the design, fabrication, and implementation of a novel WQMS-LoRaWAN IoT system. Our portable, real-time water quality monitoring system is well-suited for use in rural areas, as it continuously measures key water

parameters and wirelessly transmits the data via the internet, regardless of location or time constraints. The following highlights the key innovations and contributions of our work:

- (i) We have developed a state-of-the-art WQMS utilizing LoRa and LoRaWAN technology, overcoming the challenges posed by short-range communication systems. Our system comprises a smart node equipped with multiple sensors, connected to an Arduino UNO microcontroller-based board, which is further augmented with a LoRa shield for seamless wireless communication with the LoRaWAN gateway. This gateway connects to the TTN network via the internet, and the entire system is powered by an environmentally friendly renewable energy source (solar cell).
- (ii) Our portable, floating, and waterproof WQMS boasts a unique design that seamlessly integrates into rural environments, providing real-time water quality monitoring and facilitating the detection of changes in water parameters. This data is then transmitted to the IoT cloud for analysis.

In this work, we present a novel LoRaWAN-based WQMS tailored for rural areas, which incorporates the following key features:

- (a) We designed and fabricated a compact, IoT-based solar-powered water monitoring system that leverages LoRaWAN technology, an Arduino microcontroller-based board equipped with a LoRa shield, and multiple sensors (pH, TDS, turbidity, and temperature) to assess various water quality parameters. This portable, waterproof system features an integrated solar cell for enhanced durability and usability.
- (b) We introduced a new algorithm, implemented using the Arduino Integrated Development Environment (IDE), to consolidate data from multiple sensors into a single packet with eight payloads. This packet is then periodically transmitted via a multi-channel LoRaWAN gateway to the TTN server.
- (c) We developed a user-friendly Graphical User Interface (GUI) on the ThingSpeak IoT platform, which is integrated with the TTN server. This allows for the simultaneous display of real-time data on a web-based dashboard and the ThingView mobile application, enabling users to monitor data on their devices (PCs and smartphones).
- (d) We deployed and evaluated our proposed WQMS-LoRaWAN system in a real-world rural setting, demonstrating its effectiveness and accuracy in comparison to laboratory instruments.

The paper is structured as follows: Section II reviews the research background and related studies; Section III details the methods and materials employed; Section IV elaborates on the design, fabrication, and implementation of the WQMS system; Section V presents the system's functionality testing and validation against laboratory results; and Section VI concludes the paper, offering suggestions for future work.

3. Background and related works

Living The development of the economy and agriculture sectors keep increasing unceasingly causing pollution in the urban and rural areas. This causes certain areas especially rural facing the problem of lacking clean water for daily use, livestock watering, and for their crops. Water quality assessment is a real need in such areas to ensure the suitability and safety of the water source for diverse purposes for instance irrigation, drinking water supply, industrial cooling, and bathing. The water quality assessment can be classified into physical, chemical, and biological analyses. The parameters of these assessments deliver a whole picture of the water quality all these aspects need to be covered. Water Quality Indices is a very useful tool for professionalism to refer to. The Water Quality Indices provide a clear and complete picture of the water

quality standards. These standards contain information about the water quality and the behaviour of the water resources. There are six classes of water based on its usage, namely: Class I, Class IIA, Class IIB, Class III, Class IV, and Class V. A water quality monitoring system is required to identify the different water classes. Different LAB instrumentations can be used to measure the parameters related to water quality such as pH, TDS, turbidity, Manganese, Ammonia-Nitrogen, temperature, and Nitrate-Nitrogen.

IoT is a recent paradigm of communication technology, where all objects with communication interfaces, such as sensors, appliances, smartphones, tablets, and laptops, can connect with the Internet. The main intention of IoT is to form a global and smart world using a global network system; thus, it creates a sense for data collection from a huge number of devices/sensors/nodes worldwide and makes it available over the Internet. IoT applications enhance all areas of our daily lives and become more inspiring and pervasive in many emerging domains, including environmental monitoring, smart grid, smart city, home automation, smart agriculture, healthcare and medical aids, and industrial automation which is known as Industrial IoT (IIoT). IoT applications with massive sensors need efficient wireless technologies which provide a wide range, energy efficient, cost-effective with low-complexity end nodes (Short & Twiddle, 2019; Wang et al., 2019). Basically, it wirelessly connects battery-powered sensors; thus, the profile of power usage must be wisely designed to prolong the lifetime of batteries (Goundar et al., 2015; Schneider et al., 2018). The range of communication needs to be extended from short-range distances up to several kilometres since end nodes are disseminated throughout a wide operation area. By the consideration of all these requirements, a low-power wide-area network technology. LPWANs empower an increasing number of IoT applications in a wider geographical coverage, with a lower bitrate, and a longer lifetime. Thus, LPWANs gained popularity due to low power consumption and long-range and their multiple applications in the IoT applications. Driven by the growing variety of IoT applications and the shortage and limitations of existing wireless technologies in terms of scalability and communication range, new emerging LPWAN technologies have been developed. Existing LPWAN networks can be classified into three main categories depending on their requirements for supplementary infrastructure: (i) Cellular infrastructure (NB-IoT), (ii) Third-party infrastructure (Sigfox), and (iii) Stand-alone autonomous networks (LoRa and LoRaWAN).

This section reviews existing studies on smart water quality monitoring systems, found by searching with keywords such as 'smart systems for water quality monitoring' and 'Internet of things for water quality' in two databases: Scopus and Web of Science (WoS). The search yielded 201 articles from WoS and 376 articles from Scopus. To refine the search, the keyword 'LoRa' was included, resulting in 42 articles in Scopus and 9 articles in the WoS database. To further identify the most relevant articles, the keyword 'LoRaWAN' was used, which produced 23 LoRaWAN articles in Scopus and 5 articles in WoS. After removing duplicates from the two databases, a total of 24 articles remained, focusing on IoT-based water quality monitoring systems using LoRaWAN technology.

For the sake of brevity, the reviewed smart water quality monitoring studies have been summarized and compared in Table 1. Overall, many systems for water quality monitoring that utilise various communication technologies, parameter sensors, and microcontrollers have been proposed in the literature. Most of the reviewed systems have been tested or implemented in a real environment, and most of them were validated via simple prototypes in the laboratory without finished product fabrication or validation using laboratory instruments. In addition, none of these studies considered the development of both GUI for smartphones and Web-based dashboards, and most of them used one dashboard only. To the best of our knowledge, none of these studies are suitable for application in the real environment of rural areas that suffer from a lack of network coverage and require a standalone and cost-effective wireless network for real-time monitoring with a sustainable power source and

Table 1
Comparison of Existing WQM Systems.

WQM System	Focus Criteria/Parameters						Wireless Interface	Controller	LoRaWAN TTN	GUI or Dashboard	Real Implementation	IoT-based	Solar-Powerd	Floating	Waterproof
	pH	TDS	Turbidity	Temperature	Other parameters	Validation									
Liu et al. (2018)	✓		✓	✓	✓		LoRa	Arduino Pro Mini		✓		✓			
Tolentino et al. (2020)	✓	✓	✓	✓	✓	✓	LoRa/LoRaWAN	Packetduino		✓	✓			✓	
Alset et al. (2020)	✓		✓	✓	✓		LoRa	Rx64M MCU		✓		✓			
Fathoni et al. (2020)	✓			✓	✓		LoRa								
JIAO and Xuan (2018)	✓		✓	✓			LoRa	Arduino Mega		✓		✓			
Vijayakumar and Ramya (2015)	✓		✓	✓	✓		Wi-Fi	Raspberry Pi B+		✓	✓	✓			
Raut and Shelke (2016)	✓		✓	✓			ZigBee	PIC		✓	✓				
Myint et al. (2017)	✓		✓	✓	✓	✓	ZigBee	FPGA		✓	✓	✓			
Saravanan et al. (2017)	✓		✓	✓	✓	✓	LoRa	Arduino Nano		✓	✓	✓			
Li et al. (2018)	✓	✓		✓		✓	Wi-Fi	Arduino Uno		✓	✓	✓			
Prasad et al. (2015)	✓			✓	✓	✓	GSM	Waspmote		✓	✓	✓			
Das and Jain (2017)	✓			✓	✓	✓	GSM/ZigBee	LPC 2148		✓	✓	✓			
Qin et al. (2018)	✓			✓	✓	✓	Wire	FPGA		✓					
Ngom et al. (2019)	✓			✓	✓		LoRa/LoRaWAN	Arduino Mega		✓	✓	✓	✓		
Wu and Khan (2019)	✓		✓	✓	✓		LoRa/LoRaWAN	ATmega32U4	✓	✓	✓	✓		✓	✓
WQMS-LoRaWAN	✓	✓	✓	✓	✓	✓	LoRa/LoRaWAN	Arduino Uno	✓	Both	✓	✓	✓	✓	✓

maintenance-free system.

In the literature, many studies investigated the usage of IoT in water quality monitoring. In (Liu et al., 2018), the authors proposed an IoT water quality monitoring based on LoRaWAN. The system consists of an Arduino Pro Mini, sensors (temperature, turbidity, conductivity, and pH), a LoRa module, and a solar panel. The system updates the data to a cloud database over the gateway using MQTT. However, among the drawbacks of the proposed system was the lack of system validation using laboratory instruments and the utilization of a private dashboard for data monitoring which makes it limited for a specific use case. In (Tolentino et al., 2020; Tolentino et al., 2021), the authors proposed an IoT-based device to allow local fish farmers to monitor various water parameters including pH, water level, temperature, dissolved oxygen, TDS, oxidation–reduction Potential, and turbidity using a smartphone. It also used different actuators to control fish-related activities like aerators, water filters, peristaltic pumps, water pumps, fish feeders, and heaters. The developed device used Packetduino as a microcontroller with a LoRa interface for data transmission to the Internet. However, system complexity, size, cost, and weight are among their drawbacks that need to be optimized according to the authors. In addition, the system needs to be powered using the main power source which might not be available in rural areas.

In (Alset et al., 2020), the authors compared the performance of LoRa nodes under different frequencies (433 MHz, 865 MHz, and 915 MHz) based on the signal strength and the required energy using MATLAB. The study focused more on LoRa interface behaviour during the transmission of water quality-related information for example temperature, turbidity, pH, and GPS coordinates. The study simulated and analysed the LoRa node performance at different frequencies based on various spreading factors. Nevertheless, no real system development or prototype was carried out to monitor water quality. In addition, the study depends on the existing dataset rather than experimental sensor measurements. Ref. (Fathoni et al., 2020) implemented water quality monitoring using Rx64M MCU, pH, DO conductivity, and temperature sensors. The system uses LoRa to broadcast data over MQTT to the Grafana visualization platform. However, the system has limitations in terms of portability, waterproofing, and energy efficiency since it is battery-powered without any sustainable power source. Therefore, it is not suitable to be implemented in remote areas. The system prototype was tested in the LAB and it was not implemented in a real environment and no practical measurements were conducted for validation. Another study (Jiao & Luo, 2018) proposed a water quality monitoring system using Arduino Mega2560, LoRa shield with turbidity, pH, and temperature sensors. The acquired data by the sensors are updated on the JAVA-based website. Three sensors are used to check the uploaded information to the database. The study focused more on database design software development instead of system hardware implementation and validation. Ref. (Ngom et al., 2019) proposed a LoRa-based acquisition node that gathers information using Arduino Mega 2560 and four sensors (pH, electrical conductivity, oxidation/reduction potential, and temperature), then updates to the Global Visualization via a gateway. The system is powered using a fixed and separated solar panel and it was tested at the Botanical Garden pool in the faculty. However, the system lacks some features such as portability, floating, and the validation of the results. Ref. (Wu & Khan, 2019) developed a mobile monitoring system for water quality using USV, ATmega32U4 microcontroller, and Microchip RN2903 LoRa technology for Lake Dardanelle. Four sensors are used to collect data including pH, turbidity, DO, and temperature sensors. The gathered information is uploaded to the TTN and then to the MySQL database for further analysis. However, the usage of USV to carry the system increased system cost and complexity. Also, communication link stability and data transmission reliability are difficult to achieve with a mobile node.

Vijayakumar & Ramya (2015) presented the design and development of a cost-effective, real-time water quality monitoring system using IoT technology. The system employs various sensors to measure the physical

and chemical parameters of water, including temperature, pH, turbidity, conductivity, and dissolved oxygen. A Raspberry Pi B + model serves as the core controller to process the data collected from the sensors. The sensor data can then be accessed and viewed online through cloud computing, ensuring the safety of drinking water by continuously monitoring its quality. The Wi-Fi has a limited range, and no system prototype was developed or tested. In (Raut & Shelke, 2016), the authors presented a wireless acquisition system for water quality monitoring, aiming to overcome the limitations of traditional wired monitoring systems, such as high cost, installation complexity, and maintenance challenges. The wireless acquisition system consists of three main components: sensing nodes, a wireless transmission module, and a central control unit. Sensing nodes are equipped with various sensors to measure water quality parameters, such as temperature, pH, dissolved oxygen, and turbidity. These nodes are responsible for collecting and processing data, which is then transmitted wirelessly to the central control unit using a ZigBee module. Similarly, a reconfigurable smart water quality monitoring system for the IoT environment was introduced by Myint et al., (2017). The system is composed of three main components: IoT-based water quality sensors, a wireless communication module, and a cloud-based data processing and storage platform. The data collected by these sensors is wirelessly transmitted to the cloud-based platform over the ZigBee module which is a short-range communication technology.

In (Saravanan et al., 2017), a smart water grid management system utilising LPWAN-IoT technology is presented. The system consists of IoT-based sensors, LPWAN communication modules, and a centralized data processing platform. IoT sensors are employed to collect real-time data on various water parameters, such as flow rates, pressure, and water quality. The collected data is transmitted using LPWAN technology, which offers long-range communication, low power consumption, and the ability to connect numerous devices. The study lacks real-world testing and case studies to validate the effectiveness of the proposed system. Another Wi-Fi-based system consisting of WSN-based sensors, and a central data processing unit was presented by Li et al., (2018). The sensors are responsible for collecting real-time data on water quality parameters, such as temperature, pH, dissolved oxygen, and turbidity. Although the study provides valuable insight into the potential benefits of using WSN technology for water quality monitoring, no real-world testing was conducted. A GSM-based water quality monitoring system for measuring various water quality parameters, such as temperature, pH, dissolved oxygen, and turbidity was introduced (Prasad et al., 2015). However, the study lacks a detailed examination of power consumption and strategies for optimizing energy efficiency within the system. Authors Das & Jain (2017) presented a detailed description of an IoT-based water quality monitoring system using ZigBee and GSM that can provide real-time data to ensure the safety and purity of water resources. However, some potential limitations should be considered. For example, the system was evaluated in a laboratory and a relatively small field test, so it is unclear how well it would perform in larger-scale implementations. Qin et al. (2018) discussed a unified water quality monitoring system that employs pH, free chlorine, and temperature sensors using FPGA and a wired network. The sensor configuration is dependable, cost-effective, and has fast response times, making it a valuable tool for constant monitoring of water quality aspects. However, the article could have discussed the potential challenges and limitations of the system, such as calibration and maintenance requirements, sensor life span, and the possible impact of external factors on sensor performance.

Miao et al. (2022) described the creation of a monitoring system for monitoring air and water quality on a university campus. This system utilises LoRaWAN technology to collect and transmit data from various sensors that track temperature, humidity, PM2.5, and water quality. The authors note the system's cost-effectiveness and potential for growth. However, the article lacks detailed information on the accuracy and reliability of the collected data, as well as any information on how the

data is being used or shared. Additionally, the authors do not address any potential ethical or privacy concerns associated with monitoring individuals' activities and behaviours on a university campus. In (Albaidy et al., 2022), an Airborne IoT Network (LAP-AIN) based on low-altitude platforms for monitoring water quality in difficult tropical climates is introduced. By employing affordable solar-powered drones fitted with IoT sensors, the authors aimed to address the issues faced by conventional water quality monitoring techniques. The paper delves into the system's structure, network planning, and simulation outcomes to showcase the efficiency and dependability of LAP-AIN. However, the study could benefit from a more in-depth analysis of the potential limitations and challenges of implementing the system in real-world scenarios, such as regulatory constraints, maintenance requirements, and the impact of extreme weather conditions on drone performance. Ref. (Jáquez et al., 2023) focused on improving the LoRa communication system and incorporating an unsupervised anomaly detection algorithm in an IoT-based water quality monitoring system. The researchers suggest extending LoRa coverage using a mix of terrestrial and satellite communication, providing improved reliability and accessibility for distant regions. The study effectively shows real-time water quality tracking and early anomaly detection. Nevertheless, the authors could have explored the scalability of their proposed system, as well as the potential challenges that may arise in the deployment of such systems in rural areas. Lastly, an examination of the system's energy consumption and maintenance requirements would have provided a more comprehensive understanding of the system's long-term feasibility.

Incorporating insights from related works enhances our understanding of LoRa-based water quality monitoring systems. Notably, the study by Li et al. (2017) presents an innovative approach to water meter reading using LoRa communication technology. This research demonstrates the application of LoRa in a multi-level relay and concentrator structure for effective and efficient water meter reading in urban environments. Their system, featuring ultra-low power consumption and long-range wireless communication, offers valuable lessons for our WQMS-LoRaWAN system, particularly in terms of network design and energy efficiency. This reference underscores the growing relevance of LoRa technology in diverse urban and rural applications, reinforcing the potential of our proposed system to extend beyond its current rural-focused application. The study's emphasis on achieving a balance between transmission efficiency and power consumption resonates with our system design considerations, particularly in ensuring sustainable and continuous operation in varied environmental conditions.

A study by Ragnoli et al. (2020) demonstrates an application of LoRa technology in environmental monitoring. This research provides a comprehensive model for a flood-monitoring system utilizing a customized electronic board, emphasizing the system's low power consumption and extensive coverage, attributes that are crucial for remote monitoring applications. The system's modularity and adaptability to various sensor types are notable, illustrating the potential of LoRa technology in diverse environmental scenarios beyond flood detection. This inclusion not only enriches our literature review but also aligns with our study's focus on harnessing IoT and LoRaWAN for real-time water quality monitoring in rural areas. The research underscores the importance of energy efficiency and the versatility of IoT devices in LPWANs, offering valuable insights and parallels to our own work in developing an efficient, adaptable, and sustainable water quality monitoring system.

Zakaria et al. (2023) introduce an innovative flood monitoring and warning system (FMWS) utilizing LoRaWAN technology. This system is specifically designed to maintain extensive network connectivity, consume minimal power, and utilize low data transmission rates, thereby offering a cost-effective and user-friendly solution for real-time flood level monitoring and risk assessment. It employs an HC-SR04

ultrasonic sensor integrated with an Arduino microcontroller to measure flood levels and assess risk statuses, which are updated on The Things Network and integrated into TagoIO and ThingSpeak IoT platforms through a custom-built LoRaWAN gateway. The system's solar-powered, standalone design ensures sustainability and continuous operation, making it an effective tool for early flood warnings and real-time updates to authorities and residents via mobile applications and web-based dashboards. This study not only demonstrates the system's practical implementation and effectiveness but also evaluates the performance of the LoRa/LoRaWAN communication interface in various aspects such as signal strength and packet delivery, offering insights into the system's adaptability and scalability for broader applications in environmental monitoring.

The proposed system tackles multiple issues in the existing systems that were developed in the literature. The novelty of WQMS-LoRaWAN is from the consideration of several criteria in its design and fabrication. The system is compact, portable, lightweight, waterproof, expandable, cost-effective, and floatable. The system has benefited and combined the advantages of the existing systems into an all-in-one unique system. Firstly, the integration of multiple sensors in a single microcontroller (Arduino UNO) will be a good option for building cost-effective multi-sensor smart nodes with the ability to be extended by including more sensors to monitor other water quality parameters. Such a combination reduces the overall cost of the system compared to the market-available wireless sensors. Secondly, the usage of a license-free frequency spectrum transmission network (LoRa nodes), with low power and wide coverage network (LoRaWAN) will be privileged over the existing systems that utilise short-range communication technologies (ZigBee, Bluetooth, Wi-Fi) or commercial networks (GSM, 3G, 4G, NB-IoT, Sig-Fox). Thirdly, the development of the new data acquisition algorithm based on IDE and the GUI based on open-source IoT platforms and servers (TTN, ThingSpeak, ThingView) will improve the public experience in rural areas to access data easily in real-time via public/private channels using their Internet-connected devices. Fourthly, the utilization of a solar cell with an Arduino-based solar shield charger will guarantee the sustainable operation of the proposed system in remote rural areas with lower energy constraints and less human intervention. Ultimately, the WQMS-LoRaWAN system's real-world test at Gombang Lake demonstrated its floating capability, waterproof features, portability, and compact design. This field validation not only confirmed its effectiveness but also showcased its advantages over laboratory instruments, enhancing its usability and broader applicability.

4. Methods and materials

This section provides an overview of the techniques and materials utilised in this study, as well as a description of the stages and processes followed to develop and implement the LoRaWAN-based water quality monitoring system. The method for choosing research materials is also outlined. The methodology flowchart can be found in Fig. 1. Our research commenced with an examination of the limitations of existing WQMS systems, followed by identifying research gaps. In the modelling phase, our focus is on system architecture and layout, component selection, and tool investigation for constructing the system prototype and developing the WQMS-LoRaWAN system. The system's enclosure design is created using NX Siemens software, and a 3D-printed prototype is produced from ABS plastic. The WQM system's design and implementation, utilizing LoRa technology, are carried out. Connections between various sensors in the WQM prototype and the attached LoRa system (including sensing node, gateway, power source, and IoT cloud) are set up and tested. Once the hardware installation and implementation are completed, software development and GUI design are executed to accomplish the necessary tasks. Then, the design is rechecked to

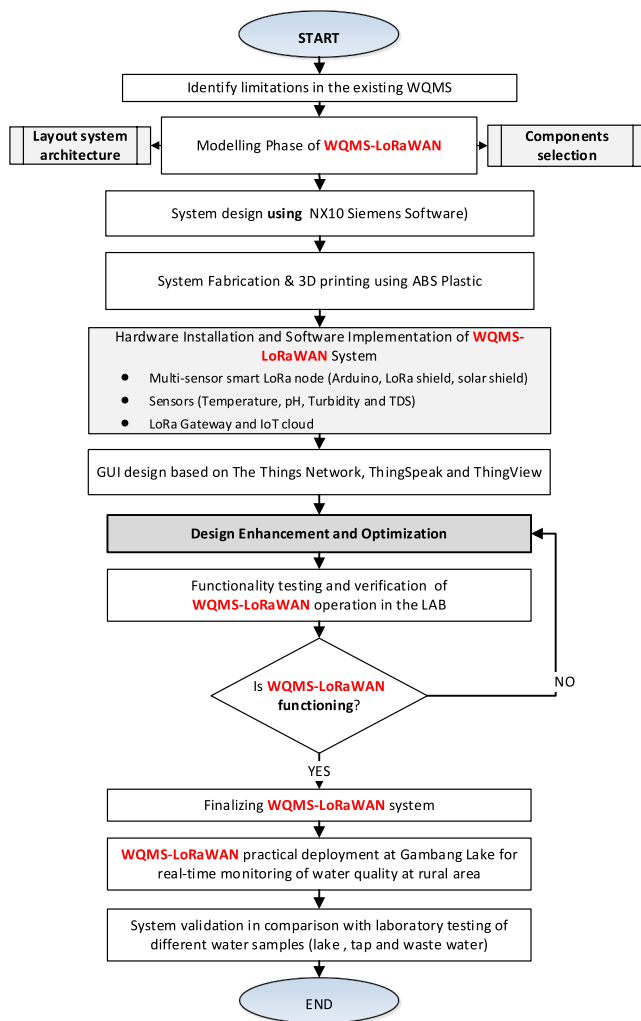

Fig. 1. Flowchart of research activities.

verify the system's functionality and identify whether any problem exists. The system returns to the previous phase, which is enhancement and optimization when any problem is found. The WQMS-LoRaWAN system is considered complete when it demonstrates strong performance and passes functionality testing. Practical implementation and performance assessment of the WQMS-LoRaWAN system are executed to confirm its effectiveness.

4.1. Components selection

The required research components to build and fabricate the proposed system were selected after conducting a market survey on the available materials and prices. Several criteria were considered during component selection, including size, cost, operating conditions, applicability, and reliability. For example, we surveyed the available water parameter sensors included in the WQM system in the local market to compare the specifications and prices. The total cost of the proposed system including the cost of materials and fabrication service is around 240 USD. The following hardware and software components were selected.

The hardware components include Arduino Uno Rev3 (Arduino, 2023), Cytron 915 MHz Lora RFM shield (Cytron, 2021), 915 MHz LoRa Gateway Raspberry Pi Hat (Cytron, 2022), Raspberry Pi 3 Model B+ (Pi, 2020), Temperature (DS18B20) sensor, pH (E-201-C) sensor, Turbidity (SEN 0189) sensor, Gravity: Analog TDS sensor (SKU SEN0244), Solar charger shield v2.2 (Seeedstudio, 2021), LiPo rechargeable battery 9 V

5200 mAh, 2020 PCB connector housing 2 ways (Cytron, 2020), and SC10050 Arduino compatible 5.0 V 100 mA solar cell.

The software components include Nx Siemens software, Fritzing software, Arduino IDE software, The Thing Network, ThingSpeak Cloud, and ThingView. After the components selection process, we designed, fabricated, and implemented the WQMS-LoRaWAN system for water quality monitoring in rural areas.

The selection of electronic components for the WQMS-LoRaWAN system was guided by several key criteria: cost-effectiveness, availability, ease of integration, and the need for modularity and adaptability in various rural water monitoring scenarios. We chose off-the-shelf elements for several reasons:

Cost-Effectiveness and Accessibility: Using readily available components ensures that the overall cost of the system remains within a reasonable range. This is particularly important for potential replication and scaling in rural areas where resources may be limited.

Ease of Integration and Adaptability: Off-the-shelf components allow for greater flexibility in modifying or upgrading the system. As the water quality monitoring needs may vary across different rural regions, the ability to easily replace or add components is beneficial.

Reliability and Community Accessibility: Using standard, well-tested components ensures reliability and also makes it easier for local technicians to understand, repair, or modify the system, fostering community engagement and local capacity building.

Regarding the implementation on a custom board, while it is true that a custom-designed board could potentially lead to a more compact and energy-efficient design, there are trade-offs to consider:

Development Time and Cost: Designing and testing a custom board requires significant investment in terms of time and resources. For the initial phase of our project, our priority was to establish a functioning prototype that could be deployed and tested in real-world conditions rapidly.

Flexibility and Scalability: Custom boards, while efficient, can be less flexible in terms of making quick modifications based on field feedback or integrating new sensors.

Maintenance and Repair: In rural settings, the ease of maintenance and repair is crucial. Off-the-shelf components are more accessible and easier to replace or repair by local technicians who may not have specialized skills in custom electronics.

4.2. System architecture

The overall system architecture of WQMS-LoRaWAN is illustrated in Fig. 2. Sensors are placed in the under-monitoring water source, such as a lake or a river. The pH sensor is utilised to define the acidity and alkalinity in the water. Meanwhile, the turbidity sensor is employed to detect the cloudiness of the water bodies. The DS18B20 sensor is utilised to identify the water temperature, while the TDS sensor is used to determine the salt concentration in the water. The four sensors measure the water quality parameters and transfer the information to the multi-sensor smart node, which consists of an Arduino Uno microcontroller-based board and LoRa shield. The microcontroller was used to gather data from different sensors and periodically send them as a payload stream over the 915 MHz Cytron LoRa radio to the LoRaWAN gateway.

LoRa is the radio protocol, while LoRaWAN is the network protocol. LoRaWAN is a star topology network. This network uses sub-GHz frequency to communicate, which is regulated by each country's regulatory body. The frequency range in Malaysia is from 919 MHz to 923 MHz. The information will be transmitted by the LoRa gateway to the cloud, which is TTN, ThingSpeak, and ThingView application.

The monocrystalline solar cell was placed on top of the smart node to harvest sunlight and generate the required electricity to supply the power for the sensors, microcontroller, and LoRa shield. The Solar Charger Shield v2.2 is an essential component of our WQMS-LoRaWAN system that was attached to the Arduino UNO R3. It functions as an interface between the solar panel and the system's microcontroller,

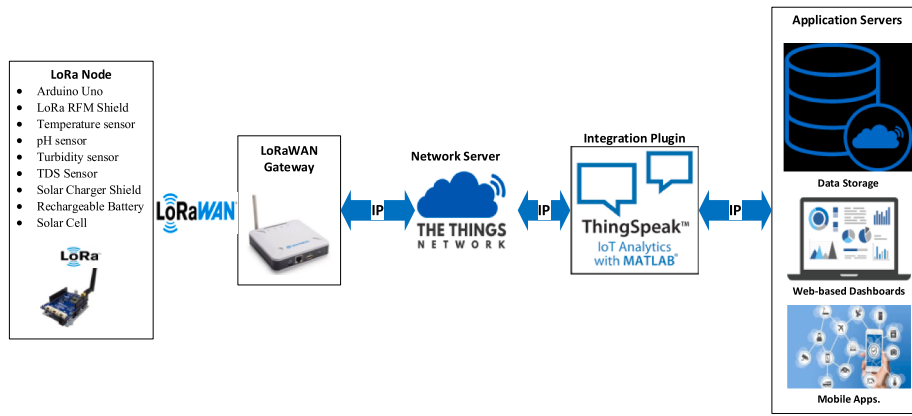

Fig. 2. Overall system architecture.

enabling efficient charging of the system’s battery using solar energy. This shield is specifically designed to manage the energy harvested from the solar cell, ensuring that the battery is charged safely and efficiently during daylight hours. Additionally, it regulates the power supply to the system’s components, contributing to the overall energy efficiency and sustainability of the WQMS-LoRaWAN. The inclusion of the Solar Charger Shield v2.2 is pivotal for ensuring that our system remains operational in rural areas, where access to conventional power sources might be limited. This choice aligns with our goal of developing a self-sustaining, environmentally friendly monitoring system suitable for remote applications.

Energy efficiency is one of the key features of LPWAN to meet IoT application needs. Hence, the energy consumption of the sensing node is one of our system design considerations. Energy efficiency is a key player for extending the system’s lifetime. This criterion is well addressed by LoRa nodes that can run with the least maintenance and last for a long (up to 10 years). The energy consumption of LoRa nodes includes two types, (i) the consumed energy by the node’s controller that depends on the selected host board, and (ii) the wireless transmission energy that relates to LoRa shield and node activities. Although LoRaWAN technology has lower energy consumption compared to other wireless technologies, energy-saving is among the key considerations to enhance its performance.

Class A LoRaWAN devices are the furthestmost energy-efficient compared to other classes. Hence, we have selected Class A LoRaWAN in our system to improve the energy efficiency of wirelessly data transmission. Moreover, we have utilised renewable green energy resources with a rechargeable battery for the sustainable operation of our system regardless of the consumed energy by the microcontroller and sensors. The prototype employs a LiPo rechargeable battery, known for its efficiency and compact size. The battery is strategically placed within the enclosure to minimize direct exposure to sunlight, thereby reducing the potential for heat-induced degradation. The system’s enclosure, designed using PLA material, provides a protective barrier against direct sunlight. This design consideration helps in shielding the battery from excessive heat, which is crucial for maintaining its integrity and prolonging its life. During the deployment at Gambang Lake, we carefully observed the battery’s performance under natural sunlight conditions. This real-world testing is crucial in evaluating the battery’s resilience and in making necessary adjustments for future iterations.

As soon as the gateway collects the data from the smart nodes, the data payloads will be transmitted to the IoT cloud, which is the TTN server. The TTN is integrated with the ThingSpeak IoT platform and ThingView mobile apps. The water quality information will be available either on web-based or mobile-based dashboards, and the users can easily access the water quality parameters by using their Internet-connected devices. The system runs depending on the developed coding and algorithm in the Arduino. The time interval for data gathering

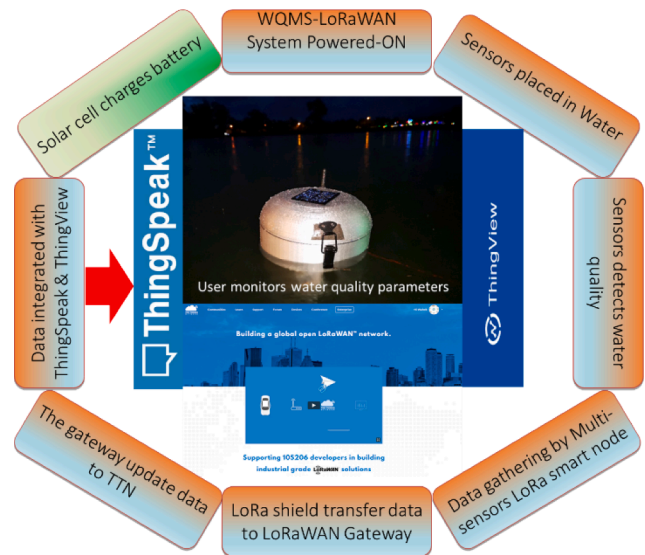

Fig. 3. Flow Chart of WQMS working.

from sensors, packet size, data encoding, and decoding in addition to the LoRa configuration parameters are set using the Arduino IDE open-source platform. This system can be extended by adding more sensors and even actuators in real applications. The system’s operational procedure is depicted in Fig. 3.

4.3. System design

Siemens NX10 software was used in this project to design the WQMS-LoRaWAN enclosure. Before designing the prototype, a few criteria were considered. The design is in 3D because the system needs to be

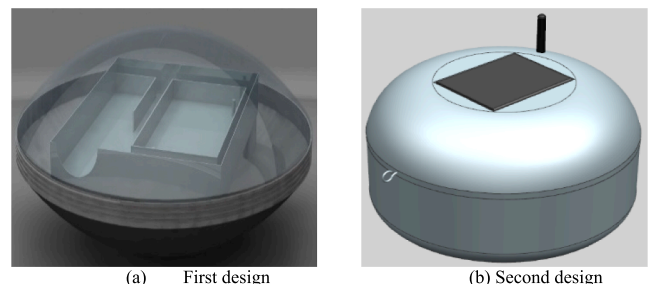

Fig. 4. System design using NX10 software.

fabricated using a 3D printer to meet the criteria. The prototype design consists of multiple generations. The design is divided into two sections, namely, the lower and upper body parts. The system is designed on the basis of the criteria of being floatable, waterproof, and able to withstand sunlight. These requirements must be satisfied because we need to place the prototype in the lake and ensure that it will not drown. The design is straightforward and more practical with suitable dimensions. TWO main designs were proposed. The first design as illustrated in Fig. 4 (a) consists of microcontroller board holders which then were not suitable for our prototype since we need the prototype to be compact and practical which means space is very limited. The lower body part in the first design also was unsuitable since the prototype needed to float instead of submerged in water. In addition, it will be difficult to place the solar panel on the upside. Therefore, the round shape of the lower body part may affect the buoyancy of the prototype, thus it is changed to flat in the next design to make sure it floats. The second design is very straightforward and more practical as shown in Fig. 4 (b). The dimension of the second design was a little bit bigger than the first design to be more practical and potentially add attraction to our prototype. Consequently, our prototype is more practical and appealing. The upper body part is used to cover the sensor module and store the Arduino and LoRa shield.

4.4. System fabrication and verification

The proposed system design is finalized and then it is fabricated. The fabrication process included 3D printing, drilling, surface finishing, and wiring connection. The 3D printing method is used in this project because it helps reduce material waste, minimizing errors, and producing lightweight parts. 3D printing can also be used to produce complex shapes, such as circular or spherical designs. The prototype’s materials were then listed before they were finalized on the basis of their characteristics, which comprised polylactic acid (PLA) and acrylonitrile butadiene styrene (ABS). The former is then selected as the prototype material. The main reason was that the PLA could be used to create dimensionally accurate parts. We also chose PLA over ABS because it is stronger, has greater strength, is stiffer, and is cheaper. After the 3D printing, we begin drilling to create a hole in the materials for bolts and nuts to secure the components inside the system enclosure. The drill used was a step drill to avoid any failure during the drilling. Surface finishing is necessary because the surface finish of the printed product is below a decent state. Accordingly, sandpaper is used to give the product a good and smooth surface finish. The final fabricated system enclosure (Fig. 5).

The concern about how our prototype’s enclosure handles high temperatures, particularly during sunny conditions, is an important consideration for the long-term reliability of our WQMS-LoRaWAN system. It is crucial to note that the current design is a prototype, not the final product, and is part of an ongoing development process. Considering that our prototype is strategically positioned on the water surface, it benefits from the moderating temperature effects of the surrounding water, mitigating the impact of high ambient temperatures

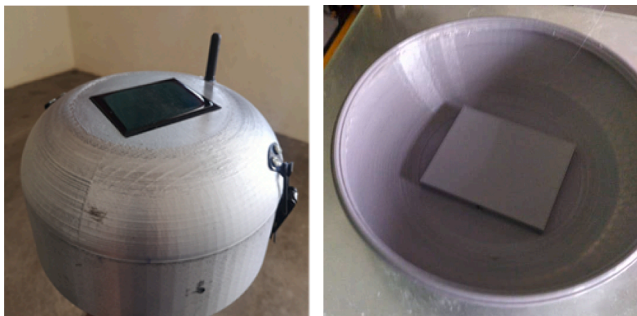

Fig. 5. 3D Printed product.

typically experienced during sunny days.

This phase also covers the wiring and installation of the system hardware components. Arduino Uno is a microcontroller board based on the ATmega328. Arduino is an open-source platform that is used as the main microcontroller and can be powered via a USB cable to a computer or powered with an AC-to-DC adapter or battery to get started. It contains a physical circuit board that can be programmed using the Arduino IDE to write and upload sketches to the physical board. The Arduino Uno can be connected to digital and analogue sensors.

Cytron 915 MHz LoRa RFM Shield is attached to the Arduino Uno to enable the wireless communication of the smart node. A solar charger shield v2.2 is also attached on top of the LoRa shield to interface between the solar panel and the microcontroller. Accordingly, Arduino Uno with LoRa and solar charger shield represent the main part of the multi-sensor smart node. Before the combination of all sensors within the smart node sensing unit, we tested each sensor in the laboratory. The calibration process of sensors with different samples of water and coding development for each sensor are performed to confirm the functionality and accuracy of all sensors as shown in Fig. 6.

Four sensors are utilised in this study for different parameter measurements. The turbidity sensor measures the water’s darkness. Turbidity specifies the degree to which the water misses its transparency. This metric is a key indicator of water quality. Turbidity blocks out the light needed by submerged aquatic vegetation. This parameter can also increase the surface water temperatures above the normal level since suspended particles near the surface help the absorption of sunlight heat. The sensor’s outputs are in the nephelometric turbidity unit (NTU). Our system uses a DS18B20 temperature sensor due to several merits including waterproof, cost-effective, long-standing stability, efficient quality, rapid response, robust anti-interference ability, long-range signal transmission, digital output, multi-measurements for relative humidity and temperature, and accurate calibration. This temperature sensor is used to detect the water temperature. The aforementioned device accurately measures the temperature because of

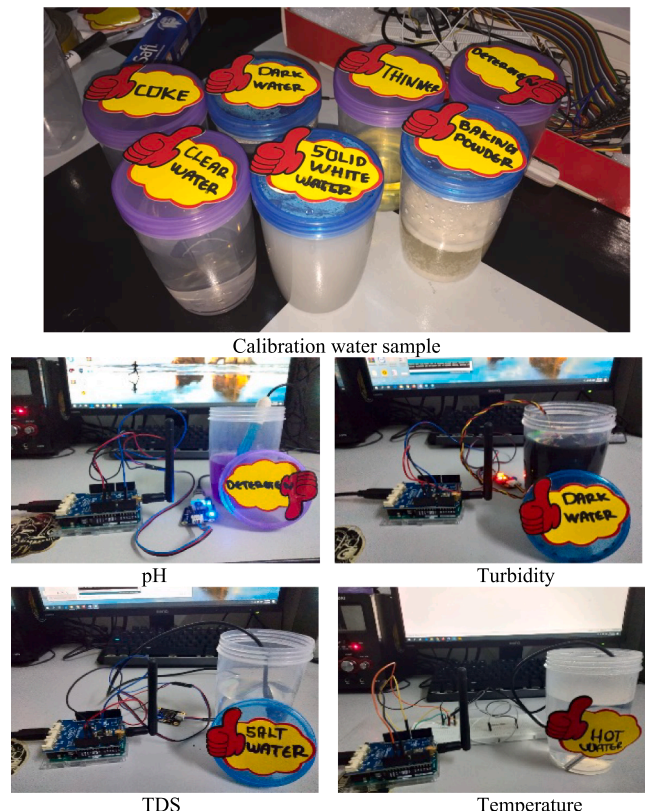

Fig. 6. Individual sensor testing and calibration.

its digital output. The temperature of the DS18B20 sensor ranges from -55°C to $+125^{\circ}\text{C}$. In our study, a pH sensor is utilised to detect the pH value, which is the most critical parameter of water quality. This metric indicates the alkalinity or acidity of a sample. The pH sensor scale is a logarithmic scale with a 0–14 range, and a neutral point being seven. Values higher than seven indicate a basic or alkaline solution. Meanwhile, values lower than seven would indicate an acidic solution. The probe must be cleaned with distilled water before performing multiple water quality tests because it is sensitive. The TDS sensor indicates how many milligrams of soluble solids are dissolved in 1 L of water. As the TDS value becomes higher, it increases the soluble solids dissolved in water and decreases the water's cleanness. The TDS sensor kit is compatible with Arduino, has a reasonable price, and is easy to use. The excitation source is an AC signal that can efficiently avoid the polarization of the probe and extend the probe's life while also increasing the stability of the output signal. The TDS probe is waterproof and may be immersed in water for extended time measurement. The output reading of this sensor is in parts per million (PPM).

At the beginning of the experiment, we tested each of the capabilities and durability of the sensor by making a calibration. The calibration is the most important step before starting the project to ensure that the sensor is working well and waterproof. At the first calibration test, we managed to study the turbidity (SEN0189) sensor output, that is, brightness calibration. We connect the sensor to the analogue input (A0). The serial monitor is used in this step of project development. Then, we calibrated the DS18B20 temperature sensor where we applied the same steps. However, the connection of the temperature sensor is somewhat different because it connects to the digital input (D8) and includes a $4.7\text{ k}\Omega$ resistor. The DS18B20 is tested in hot and cold water. We have also calibrated the TDS sensor (SKU SEN0244) by connecting to (A1) to Arduino input to measure the cleanness of the water by ppm unit. The final calibration sensor in our project is the pH (E_201_C) sensor, which is connected to the (A2) Arduino analogue input to measure the alkalinity or acidity of a sample. After the individual testing of sensors, a complete combination of circuit and coding is applied. We simultaneously measured the different water quality conditions by using a multi-sensor smart LoRa node. These tests are conducted locally without data transmission to the LoRaWAN gateway.

Communication between the smart node in our project and the IoT is established via Cytron 915 MHz LoRa RFM shield, which allows data to be wirelessly transmitted over a long distance at low data rates (<50 kbps). This LoRa shield enables ultra-long range spread spectral communication with high immunity for interference while minimal current and targets various IoT applications, such as smart agriculture, smart homes, smart cities, and building automation. The RFM LoRa shield can achieve a sensitivity of over 148 dBm using the LoRa TM modulation technique and a low-cost crystal and bill of materials. The higher sensitivity supported with the integrated $+20$ dBm power amplifier produces an industrial-competitive link budget that makes it ideal for any applications requiring range or robustness. LoRa also outperforms modulation methods in terms of blocking and selectivity, for achieving an acceptable trade-off among range, interference immunity, and energy consumption.

The RFM LoRa shield provides exceptional linearity of the receiver and Input Third Order Intercept Point. It also allows outstanding phase noise and selectivity for noticeably lower currents. It supports high-performance (G) FSK modes for systems, such as WMBus and IEEE802.15.4 g. The LoRa shield allows extra shields that are compatible with Arduino to be attached on top of it via a stackable side header. This shield also includes built-in connectors for grove sensors that enable the integration of grove sensors for various applications. Users can also integrate OLED with this shield. LoRa operates in various region-based frequencies. The LoRa network is linked in star regional anatomy stars where the end nodes are connected via one hop to the gateways within the LoRa communication range. The utilised LoRa radio shield does not contain the LoRaWAN protocol; thus, we have

integrated the LoRaWAN stack into the Arduino board. The LoRaWAN gateway functions as a relay and transfers the packets to the TTN server as the LoRaWAN network server (TTN). The LoRaWAN gateway in this project is built from Raspberry Pi 3 Model B + with a 915 MHz LoRa Gateway Raspberry Pi Hat by Cytron. The gateway HAT is based on RHF0M301-920 MHz, and it is a ten LoRaWAN concentrator module channel ($8 \times$ multi-SF + $1 \times$ standard LoRa + $1 \times$ FSK) with a 915 MHz antenna. This gateway kit was designed and developed to stack on Raspberry Pi 3, which is programmed to connect to the TTN LoRaWAN network server and collect and transfer data among all smart LoRa nodes.

The choice of the LoRaWAN gateway, was driven by several factors:

Coverage and Range: The gateway was selected for its proven effectiveness in covering the required range, which was essential for the rural deployment scenario at Gambang Lake.

Compatibility with LoRaWAN: This particular model ensured seamless integration with the LoRaWAN network protocols, crucial for the reliability of data transmission to the TTN server.

Installation Point Decision: The gateway was strategically installed on our campus, approximately 2 km from the test site (Gambang Lake).

Accessibility and Security: The campus provided a secure and accessible location for monitoring and maintaining the gateway.

We can build our IoT system to observe the water quality in real-time by connecting the smart node with the LoRa shield to the gateway. Both the LoRa shield and LoRaWAN hat that we used in the proposed system are displayed in Fig. 7.

The received sensor readings by the gateway will be sent in real-time to the LoRaWAN server, TTN. TTN is an open-source and free IoT server that utilises the data from the LoRa sensor nodes. This server allows you to freely connect many LoRaWAN gateways and LoRa devices. The TTN is a powerful global platform for LoRaWAN applications with low complexity and efficient capabilities. Moreover, this server delivers a set of open tools and open network standards for developing the next IoT applications at a lower cost, higher security levels and maximum scalability. A secure and collaborative IoT network is built using robust end-to-end encryption that covers many countries across the world. In this study, the TTN LoRaWAN server is used to collect data from our system gateway through the internet. We have defined our gateway under the gateways of the TTN network and added our applications with smart devices. Each device should have its ID with multiple keys to ensure data security. These keys need to be included when building the smart nodes using the Arduino IDE. In our case, we have defined two sensor nodes, one for prototyping and testing and the other for the final product.

Many verification steps were carried out during this phase to ensure the data flow from sensors to the TTN over the LoRa/LoRaWAN network. The sensing data, which include the encoded sensor measurements, are uploaded to the server as payload packets from the LoRa node. The data is instantaneously demonstrated on the TTN platform as encoded hexadecimal values. A new payload decoder was created at TTN based on the encoding procedure of data using the Arduino IDE at

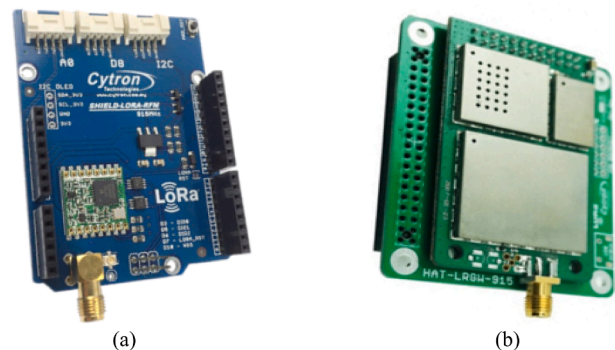

Fig. 7. (a) LoRa shield, (b) LoRa Gateway Hat.

the sensor node. Accordingly, the TTN can receive and decode the uplink data which can be traced easily to monitor the considered water quality measurements. We have selected ThingSpeak among several available integrations in the TTN to build a user-friendly interface. ThingSpeak is an open-source IoT platform for storing and retrieving data from smart devices by utilizing MQTT and HTTP internet protocols. It enables the application's creation for data logging, location tracking and status updates of sensors and actuators and enables integration with other tools and social networks. Users can access data output measurement of the system with their laptops or smartphones. The integration process was carried out to allow TTN to forward the data received from our system to ThingSpeak, which in turn makes it available to be displayed in its dashboard/channel or on ThingView mobile apps. Therefore, the proposed WQMS-LoRaWAN system can acquire data from sensors and send it to the ThingSpeak IoT server via the TTN LoRaWAN server and allow live cloud data streams to be aggregated, visualized, and analysed.

We have selected the integration with ThingSpeak due to its key features, which include: (i) the ability to easily set up devices that use common IoT protocols to send data to ThingSpeak, (ii) visualize the sensor data from third-party sources in real-time, (iii) prototype and develop IoT applications without arranging networks or program development, (iv) a free software IoT system that uses the LAN or HTTP to collect related data from sensors or items through the internet, and (v) automatically activate data and connect with third-party providers to analyse data obtained by the device using ThingSpeak for easier processing, storage, and display.

5. System development and implementation

After the individual testing for various components of the system, the implementation of the proposed design was carried out. The implemented WQMS-LoRaWAN IoT system was started by the combination of all sensors with the microcontroller and LoRa shield as one unit.

5.1. Functionality testing and design enhancement

The testing of the all-in-one sensing unit was conducted to ensure system functionalities, and the design was enhanced and optimized when needed. This phase is vital to enhance the performance of the system and identify errors either in hardware connection or in software coding. Accordingly, the issues encountered in the previous stages are pointed out and solved. This phase was repeated to accomplish a successful system implementation. For example, at the initial stage of the system implementation, the output that we measured from the water quality system should be a reasonable measurement. After compiling all the programming codes into Arduino Uno, the 4-sensor module was installed on a breadboard according to Fig. 8 to measure various water quality parameters simultaneously.

The codes of individual sensors were compiled using the Arduino IDE and the four-sensor module was installed on a breadboard to

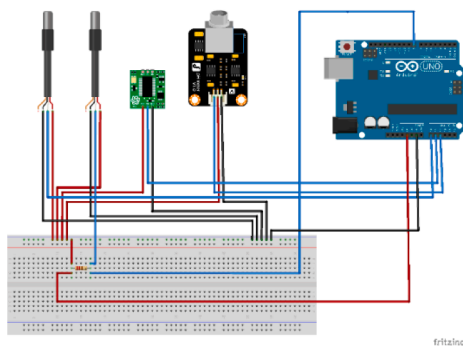

Fig. 8. Schematic diagram of sensors connection with Arduino.

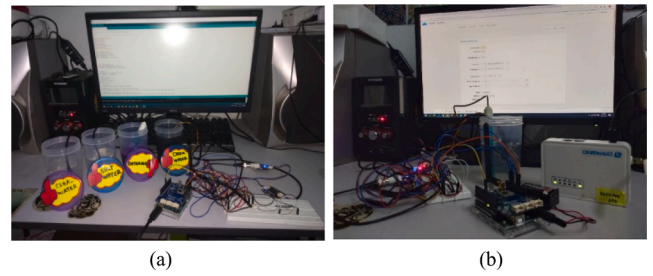

Fig. 9. System components testing: (a) Sensors combination testing via the serial monitor, (b) Connection of LoRa node/LoRaWAN gateway to TTN.

simultaneously measure various water quality parameters. The sensing unit functionality and capability were locally tested via serial monitor first, as illustrated in Fig. 9 (a). The system's wiring installation and labelling were carried out according to the system layout for diagnosing input/output malfunctions. Besides, the connection with TTN was tested using Cytron Lora RFM antenna to the LoRaWAN gateway as shown in Fig. 9 (b). The communication between LoRa and the gateway to the TTN is working smoothly. In this stage, the evaluation of the system is conducted to ensure that all sensors and Arduino with LoRa and LoRaWAN gateway are effectively functioning.

5.2. Hardware implementation of the multi-sensor smart LoRa node

Before finalizing the WQMS-LoRaWAN system, we conducted numerous tests on individual sensors as well as on the multi-sensor unit using a breadboard. One of the key attributes of the proposed system is its portability. In order to enhance the system's modularity and ease of use, a plug-and-play feature has been incorporated into the WQMS-LoRaWAN design. This feature not only facilitates easy installation and replacement of various sensors but also comes with a power management system. Specifically, the system can automatically switch between solar power and battery sources depending on availability and need. Upon connection, the core module automatically recognizes the attached sensor, retrieves its unique identifier and adjusts the communication protocols accordingly. This minimizes setup time and allows users to customize the system based on their specific monitoring needs. In practical terms, the plug-and-play feature empowers local authorities or community leaders to adapt the system for different water conditions or quality parameters, thereby maximizing its utility and adaptability in diverse rural settings. The system is suitable to be used in daily real-time monitoring of water sources in rural areas.

The system is placed in a circular form with a thin fabrication to meet the water conditions and retested after the hardware is installed. The system was enhanced and optimized when necessary until it was fully functioning. Thereafter, the system components are placed and arranged inside the enclosure (Fig. 10). The sensors are fixed in the lower body part to be closer to the water surface and easily dropped to the water.

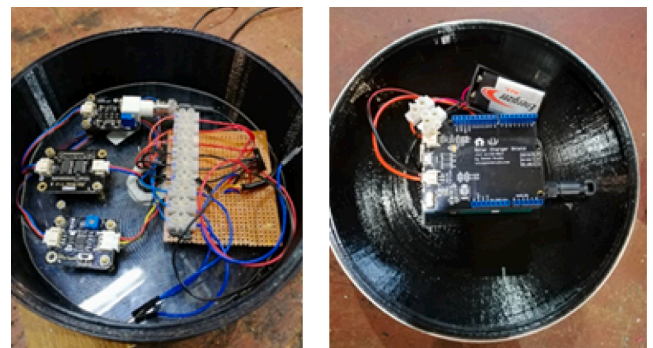

Fig. 10. Implementation of Multi-Sensor Node.

Meanwhile, the microcontroller with LoRa, solar charger, and solar cell are placed on the upside of the system. The holes for the sensors and antenna are well protected against water leakage into the system. After the components were attached to the prototype, the wiring connection was then established. The sensors connect to the module, the module connects to the board, and the board connects to the controller. The wire is held together with a cable tie and wire tape to ensure that it looks neat and assorted.

Fig. 11 shows a developed testing prototype with the final edition of the portable WQMS-LoRaWAN system placed in the water aquarium and Gambang Lake. The system's floating capability and waterproofness were tested in the laboratory prior to real implementation. The LoRa communication coverage and connectivity with the gateway were also tested in indoor and outdoor environments. The system was finalized to be appropriate for practical deployment and applicable in the considered environment regardless of the surrounding conditions.

For instance, during daylight hours, the system primarily relies on solar power, reducing the dependence on battery usage. When solar power is insufficient or unavailable, the system seamlessly switches to battery mode. This intelligent switching ensures continuous operation while optimizing energy consumption. In the context of energy sustainability, a paramount consideration for the WQMS-LoRaWAN system, we've undertaken an in-depth assessment of power utilization across all components. Our Arduino Uno core module accounts for roughly 40 % of the total system power consumption, while the SX127x LoRa Shield uses an additional 30 % and it is depending on the system situation (sending data or idle). The four water quality sensors—E-201-C for pH, SEN0189 for turbidity, DS18B20 for temperature, and SKU SEN0244 for TDS—cumulatively consume the remaining 30 % of the energy budget. Importantly, the inclusion of these sensors has a nominal effect on total power usage, elevating it by just 5–8 %. This analysis corroborates the efficacy of our solar-powered configuration in meeting the energy requirements of both the core module and various sensors. This information is especially relevant for stakeholders planning to deploy this



Fig. 11. Finalized system practical testing (a) LAB (b) Gambang Lake.

system in rural areas where energy efficiency is a critical concern.

5.3. Software implementation

The software development focuses on proposing a new algorithm (*Algorithm 1*) to gather data from a multi-sensing unit and compose it to be transmitted as a single packet periodically over the LoRa/LoRaWAN network to the TTN server. This process is known as encoding sensor readings for upload as bytes' stream to the TTN via the gateway. Algorithm 1 is proposed and implemented in the Arduino IDE platform to perform the required monitoring tasks. Multiple functions were developed to gather data from each sensor.

In our LoRaWAN-based system, we configured various parameters to optimize the node's transmission capabilities and ensure efficient, collision-free communication (Croce et al., 2019). These configurations include:

- **Spreading Factor (SF):** We experimented with two distinct SF settings: SF7 and SF12. These varying levels were tested to determine the most effective trade-off between communication range and data rate under different environmental conditions.
- **Bandwidth (BW):** Set at 125 kHz, this bandwidth is a standard setting for LoRaWAN applications, providing a balance between data rate and signal robustness.
- **Coding Rate (CR):** Typically, we set the CR at 4/5. This rate offers a compromise between transmission robustness and bandwidth efficiency, ensuring reliable data delivery without excessively consuming network resources.
- **Carrier Frequency (CF):** The CF was selected in line with the regulatory norms and standard frequency bands specified for LoRaWAN operations in Malaysia, which range from 919 MHz to 923 MHz. This careful selection ensured our system's compliance with local regulations while optimizing signal transmission quality.
- **Transmission Power (Ptx):** We adjusted the Ptx to balance the needs for transmission range and energy efficiency. The setting was fine-tuned based on the distance between the nodes and the gateway, aiming to maintain strong communication links while reducing power consumption as much as possible. This strategy is particularly crucial for our system's solar-powered design, helping to extend battery life in remote or rural settings.

By configuring these parameters, we aimed to create a network that is not only compliant with local telecommunication laws but also efficient and reliable, crucial for our system's deployment in rural water quality monitoring scenarios.

The LoRa parameters can be adjusted to achieve a trade-off between multiple features, such as data rate, range of transmission, interference robustness, and consumed energy. LoRa is a Physical Layer modulation technique proprietary by Semtech, whereas LoRaWAN is an open standard that offers a medium access control mechanism (MAC) that enables many LoRa end devices to communicate with the gateway. The LoRa Alliance supports and promotes global adoption of the LoRaWAN to ensure interoperability of all LoRaWAN-supported devices and technologies; thus, delivering IoT for a sustainable future.

The structure of the LoRa packet includes (i) Preamble (≥ 4.25 symbols), (ii) 2-byte header (iii) 2-byte header CRC, (iv) data payload (≤ 255 -bytes) and (v) Payload CRC(2-bytes). A packet initiates with the preamble, programmable 6–65535 symbols, to which 4.25 symbols are added by the radio for the sync word. Next, it is optionally followed by a header that indicates the length and Forward Error Correction (FEC) rate of the payload and describes the existence of an optional 16-bit Cyclic Redundancy Check (CRC) for the payload. The header has its own CRC, and it is always transmitted with a 48 FEC rate. The payload comes after the optional header, and it can comprise 1–255 bytes. An optional 16-bit CRC might be added at the payload's end. In the proposed system, the collected readings from the sensors are combined into a packet of eight

```
// Split both words (16 bits) into 2 bytes of 8 bits
byte payload[8];
payload[0] = highByte(tdsValue);
payload[1] = lowByte(tdsValue); //Gravity TDS SEN0244
payload[2] = highByte(turbidity);
payload[3] = lowByte(turbidity); //SEN0189 Turbidity Sensor
payload[4] = highByte(Celsius);
payload[5] = lowByte(Celsius); //DS18B20 Waterproof Temp. Sensor
payload[6] = highByte(pH);
payload[7] = lowByte(pH); //pH
```

Fig. 12. Packet payloads structure.

payloads to be sent to the LoRaWAN gateway. Each sensor reading is represented by two payloads (1-byte each). This combination denotes the payload of sensing data in the LoRa Phy Packet Format. Fig. 12 depicts the utilised code to compose eight payloads as a single packet to be updated to TTN every 10 s and will be decrypted and shown in the hexadecimal format of the decoded “binary data,” every pair digit being one “byte”, as sent by the sensors. The bytes are used to represent numbers, text, and switch status.

A payload decoder has been built in the TTN platform to interpret the received hexadecimal byte characters into human-readable information, as shown in Fig. 13. The uplink payload by the gateway is 16 bytes in length and represents the readings of four water quality parameters (pH, TDS, turbidity, and temperature) to show the gathered measurements from the employed sensors (Fig. 14). Nevertheless, the dashboard of TTN lacks a user-friendly interface and data visualization features. Consequently, we have integrated two user-friendly GUIs for water quality monitoring as part of the software development. One is a web-based ThingSpeak IoT dashboard where we have created our own channel that was integrated into the TTN platform using the channel ID, a write API key, and a read API key to enable the channel to acquire data from TTN and visualize it in the selected gauges, charts or widgets. The ThingSpeak represents IoT analytics with MATLAB. ThingSpeak IoT server has the capability to view the gathered data either as graphs, numerical values, or historical trends graphs for a selected period (daily, monthly, or annually). Four widgets were added to visualize the water quality measurements. The created channel has private and public views to support and control the privacy of displayed information. API read and write keys are exploited to share the sensor readings with other devices.

The second GUI is a smartphone-based interface using the MQTT protocol known as ThingView. The ThingView mobile application was exploited to view the graph and the reading on the smartphone because it is among the mobile applications integrated with the ThingSpeak IoT platform. ThingView enables the visualization of ThingSpeak channels

Fig. 13. TTN Payload Decoder Function.

time	counter	port	retry	devId	payload	field1	field2	field3	field4
10-42:53	0	1	retry	g5n1abe	DC50 03 A9 0A C8 03 29	564	9.37	27.6	8.99
10-42:53	0	1	retry	g5n1abe	DC50 03 A9 0A C8 03 29	564	9.37	27.6	8.99
10-42:52	0	1	retry	g5n1abe	DC50 03 A9 0A C8 03 29	564	9.37	27.6	8.99
10-42:51	0	1		g5n1abe	D9F8 03 F2 0B 36 03 2A	558	18.1	28.7	8.1
10-42:51	5	1		g5n1abe	D9F8 03 F2 0B 36 03 2A	558	18.1	28.7	8.1
10-42:50	1	1		g5n1abe	DC50 03 A9 0A C8 03 29	564	9.37	27.6	8.99
10-42:49	109	1		g5n1abe	DBEC 03 8B 0B 22 03 25	563	9.55	28.5	8.85

Fig. 14. TTN data payload form.

instantaneously via channel ID. Different configurations for the GUI view are available based on channel types (public/private), such as colour, timescale, chart type, and the number of results. The information on the water quality can be easily viewed anytime and anywhere by users through these apps. The two GUIs are synchronised, and users have two options for monitoring. The conditions of the water quality can be monitored on the spot all the time and immediately treat the water quality that has been polluted by using these two dashboards (ThingSpeak and ThingView). Further details about the integrated GUIs with their usage in the WQMS-LoRaWAN are explained in the following section.

6. Experimental results and validation

This section presents the main findings and the performance validation of the developed WQMS-LoRaWAN. As previously mentioned, the testing of the proposed system was carried out in the laboratory first before the real deployment. Several verification steps were carried out prior to the implementation of the monitoring system in the rural area of Gambang, Pahang, Malaysia. The testing scenarios of the developed system have been carried out outdoors at Gambang Lake and indoors at our laboratory. The practical test results were validated by comparison with real measurements using the laboratory apparatus at the site. After that, samples of water taken from the lake were tested again in the laboratory under various conditions in comparison with other water samples (tap water and wastewater).

While we acknowledge the limitations of our sample size, it is essential to highlight the practical aspects of our study. Our system underwent rigorous testing in a real-world environment at “Gambang Lake”. The outcomes were promising as we effectively monitored the specified water quality parameters in real-time, with the data being seamlessly transmitted to the IoT Cloud via the LoRa/LoRaWAN network. The core objective of this study was to ascertain the performance of the IoT system, both in a controlled LAB environment and in an authentic implementation scenario for verification and validation purposes. Though our LAB demonstrations employed a restricted sample, the intent was primarily to showcase the system’s inherent capabilities. It is a consensus that a broader, more encompassing sample would be instrumental for any large-scale roll-outs to holistically gauge water quality. In real-world scenarios, an ideal approach would be to deploy multiple LoRa nodes throughout the targeted lake or river. This would facilitate the monitoring of water quality across various segments of the water body. The amalgamated data could then be collated and scrutinized at the central utility servers, allowing for real-time water quality assessments based on inputs from these distributed sensing units. We have integrated these observations and suggestions into our discussion, emphasizing the scope and requirements for expansive sampling in subsequent implementations.

6.1. Water quality monitoring at Gambang lake

During the outdoor test at the lake, our primary objectives were to

assess network connectivity and the timely updating of data to our IoT platform. The multisensory node was strategically placed in the lake, with sensors submerged in the water to collect real-time data. Powering the system, a solar panel was used during the day while a rechargeable battery took over at night, efficiently managed by a solar charger shield.

Our LoRaWAN gateway, situated 2 km away on our campus, successfully received data transmitted from the lake location. The test ran continuously from 9:00 am to 2:00 pm, with multiple runtime cycles to ensure robust data collection. During these testing hours, we gathered ten readings for each of the four parameters—TDS, turbidity, temperature, and pH—utilizing a variety of instruments. The LoRa node periodically relayed this data to our gateway, which in turn uploaded the information to the TTN cloud and ThingSpeak platform.

This data was made accessible in real-time on multiple platforms—TTN, ThingSpeak, and ThingView—and could be viewed via internet-enabled devices like laptops, PCs, and smartphones. The focus of this test was not a full-scale implementation but rather a targeted evaluation of the system’s networking capabilities, sensor accuracy, and data upload reliability. Overall, the trial validated our system’s functionality and laid the groundwork for future real-world deployments.

Certainly, for a more comprehensive monitoring solution and permanent implementation, it will be essential to deploy multiple systems across various locations on the same lake. This will ensure more thorough coverage and allow for a more nuanced understanding of the water quality variables at play. By disseminating several multisensory nodes, we can capture spatial variations in water quality, thereby providing stakeholders with a holistic view of the lake’s condition. Such a multi-node deployment would also allow for greater data redundancy and improved fault tolerance, enhancing the robustness of the system. This added layer of complexity is especially pertinent for stakeholders

considering a long-term, scalable solution for water quality monitoring.

In the TTN, the information on the water quality is periodically updated depending on the time interval required to establish a connection with the gateway. This platform allows for real-time water quality tracking. The ThingSpeak also shows the information as graphs and numeric values with a historical trend graph for each sensor reading, as depicted in Fig. 15. We also have created a widget for every sensor to synchronous the data between the utilised IoT servers. The data is also saved in the channel of ThingSpeak and can be extracted for further analysis. The same real testing data can be displayed on smartphones via the ThingView application as shown in Fig. 16. The condition of the water quality can be viewed at any time, and any abnormal conditions of the water quality can be reported by using these three dashboards. Our system can be used to notify the consumers regarding the water quality and report to the responsible authorities to treat the water when needed. The application will display the data as long as the connection is stable between the gateway and the LoRa nodes. The floating capabilities, impermeability functions, and connectivity with the gateway were tested in the field at Gambang Lake.

Many tests have been conducted on the site and in the laboratory to analyse the performance of the proposed WQMS-LoRaWAN system. The reported results in this paper are observed and collected in real-time for the considered water quality parameters during a five-hour period. Since our system sends information to the cloud every 10 s in the testing scenario, more than one thousand entries have been received by the server. Thus, one thousand readings from each sensor have been averaged into ten readings (100 entries are averaged into one reading) to validate the system performance in comparison with practical measurements using laboratory apparatus. We have used 2100Q Portable Turbidimeter and SevenCompact pH/Ion Meter S220. The TDS values have been calculated based on laboratory experiments.

The gathered data by the implemented WQMS-LoRaWAN was compared with practical measurements by LAB instruments. The turbidity data was validated first. Turbidity is often used to determine if the water loses clarity due to the existence of floating particles. The cloudiness of the fluid is usually invisible to the naked eye. The higher the TDS in the water, the more visible the cloudiness, and the higher the turbidity. NTU is used by turbidity to measure cloudiness. Turbidity is often used to determine if the water loses clarity due to the existence of floating particles. The cloudiness of the fluid is usually invisible to the naked eye. The turbidity of drinking water must not exceed 5 NTU and must be below 0.1 NTU, according to the World Health Organization. During the practical test, the 2100Q portable turbidity meter was used to test the turbidity of the lake water sample. Selected obtained results from practical water sample tests in the Lab are shown in Fig. 17.



Fig. 15. Sensor readings via the ThingSpeak dashboard: (a) Chart, and (b) Gage widget.

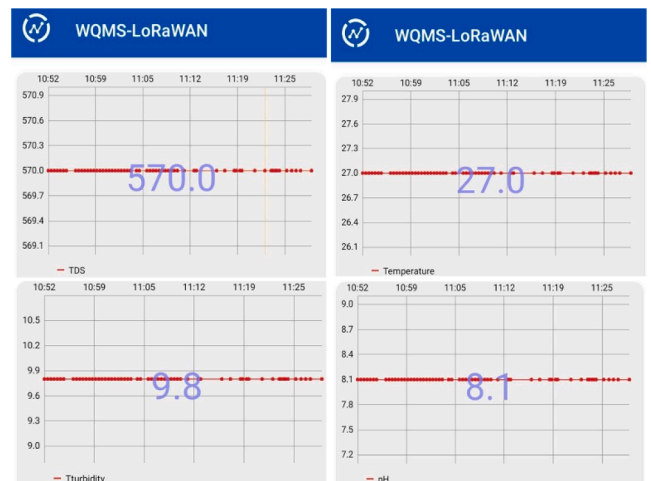

Fig. 16. Real-time lake water quality parameters in ThingView.

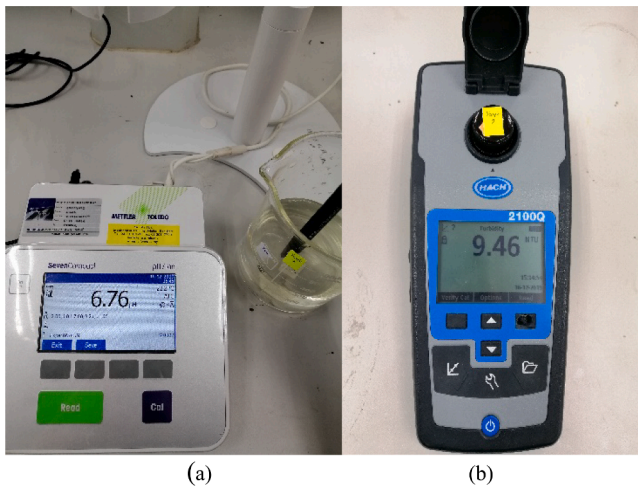

Fig. 17. Parameters values of (a) pH (b) turbidity.

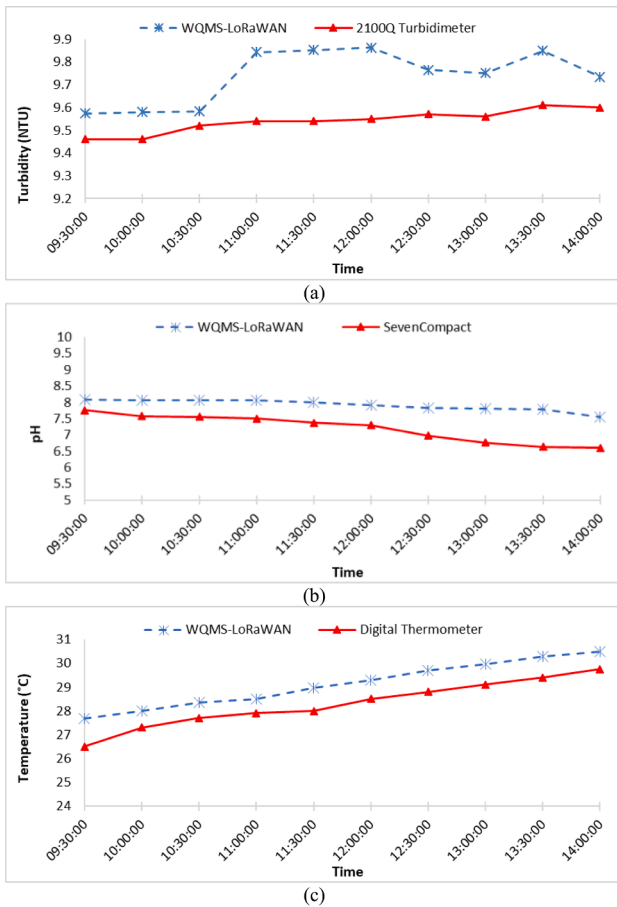

Fig. 18. Comparison of WQMS-LoRaWAN and Instrumentation measurements (a) Turbidity (b) pH, and (c) Temperature.

Fig. 18 (a) illustrates the collected data by WQMS-LoRaWAN and the portable turbidimeter. The obtained results from the turbidimeter were marginally lower than the WQMS-LoRaWAN readings which represent an average value for 100 entries. Consequently, a minor variety is noticed between real-time data and experimental results of turbidity; however, it does not mean the imprecision of WQMS-LoRaWAN. The turbidity readings for real-time monitoring changed between 9.57 and 9.85 NTU compared with 9.46 to 9.6 NTU by the turbidimeter. Overall,

the trend of both graphs is in agreement. Throughout this experiment, the turbidity (SEN 0189) sensor is validated, and it can be used for real-time monitoring of the water turbidity.

Fig. 18 (b) compares the collected results using the proposed system and the SevenCompact pH meter S220. The pH value is used to detect the concentration of hydrogen ions. This parameter measures the acidity or alkalinity of a solution. The scale of pH basically ranges from 0 to 14. Drinking water with a pH of 6–8.5 is safe to drink, while water with a pH below six is acidic, and that with a pH above 8.5 is alkaline or basic. A pH test is required to determine the water’s corrosiveness to avoid harm to human health. The equipment used was the SevenCompact pH meter S220, which can test the pH and temperature values as well. There are slight differences in the pH readings from WQMS-LoRaWAN and SevenCompact pH meter. The pH value changes due to the active microorganisms in the water. Obviously, the trend of both charts was approximately the same. In contrast, the obtained pH readings from both systems are consistent and identical irrespective of time and within the Environmental Protection Agency’s standard. The pH (E-201-C) sensor is validated and works efficiently in the proposed system hydrogen ions concentration.

Similarly, the SevenCompact pH meter S220 is used to measure the temperature of the lake’s water every 30 min and compare the measurements with the average readings from the WQMS-LoRaWAN. The temperature has a little change because the water is exposed to the sunlight when monitoring in real-time. Accordingly, the water temperature will increase or decrease. These changes have an impact on the other water quality parameters as well. Fig. 18 (c) shows the collected readings via the temperature sensor for the sensor validation over the defined period. A comparison between the gathered water temperature using the considered systems is introduced. In general, the trend was consistent for the two graphs regardless of the time. Our system measurements of the water’s temperature were slightly higher compared to the digital thermometer. The WQMS-LoRaWAN succeeded in continuously measuring the temperature using the DS18B20 temperature sensor for five hours. The data is uploaded in real-time over the LoRaWAN gateway to the IoT cloud.

The total dissolved solids of water are displayed in mg per unit of total volume (mg/L), sometimes known as ppm. The measurement of conductivity can be defined. According to the Environmental Protection Agency’s standard, the TDS level of drinking water is 50 mg/L, and the limitation is 500 mg/L. The gathered data from the WQMA-LoRaWAN throughout the practical test at Gambang Lake varied between 551 and 570 mg/L. In order to validate the analogue TDS sensor (SKU SEN0244), a sample of lake water was tested at the laboratory. The formula has been applied to calculate the TDS value which was 560 mg/L and it is close to the measured values during the site test. TDS is used to determine the total concentration of dissolved substances in the water, which measures the disintegrated minerals and natural matter present in the water. The mineral salts in water are magnesium, potassium, sodium, and calcium, which are cations, while chlorides, sulfates, nitrates, and carbonates are anions.

Therefore, the system’s effectiveness was proven during the real-time implementation in the lake. The system succeeded in periodically updating the gateway with precise data and the water quality parameters acquired by the sensors were also accurate compared to the tested water samples. The obtained results prove that our system is efficient, reliable and suitable for implementation in rural areas. Moreover, the WQMS-LoRaWAN is a standalone system that can operate and update information about water quality continuously without any human intervention. The PV solar panel provides the required power for the sustainable operation of the WQMS-LoRaWAN. The harnessed solar energy by the solar panel as a renewable energy resource is exploited to charge the LiPo battery and secure the sustainable operation of the system. The utilised battery requires six hours for full charging by the PV solar panel and can last for 13 h of continuous operation according to the conducted tests.

6.2. Water quality testing at the laboratory

In the first scenario (outdoor testing), only the leak water quality was assessed using the proposed LoRaWAN-based system. However, in the second scenario (indoor testing), three different samples of water (tap water, wastewater, and lake water) are used to validate the system’s performance under different water quality conditions. Water samples have been collected from the lake to be tested in the laboratory. When the water samples were transferred to the laboratory, the water quality parameters were affected due to the surrounding microorganisms and the way of taking the water sample. Therefore, we have noticed some variations compared with the obtained reading during the site test. The amount of time to test the water sample is restricted. The longer the time that the water sample is kept, the less accurate the parameter being tested. In the real test, the deeper the sensor is immersed, the higher the reading of the turbidity. In the practical test, only 10 mL of water sample has been tested. Temperature is the main parameter of water quality that can affect the other parameters, such as pH, DO, and conductivity. When the water sample was brought back to the laboratory for the laboratory experiments, the temperature was affected because of the room temperature.

The second validation test was carried out in the laboratory for various water samples under the same conditions. A few water samples have been taken and tested in real-time based on the four sensors of WQMS-LoRaWAN and via laboratory equipment analysis to ensure the accuracy of the obtained result from the developed system. The obtained results of the three types of water samples via real-time monitoring and laboratory equipment analysis were compared. The comparison shows that the readings were slightly different but within the acceptable range of the sensors’ accuracy. In both methods of testing, the readings varied, except that the temperature measurements were close to each other in both tests. Overall, our system was functioning well and can provide an overview of the quality of water in real-time. Table 2 summarizes and compares the obtained results from the developed system and the laboratory instruments for the considered water samples according to the tested parameters.

The traditional WQM methods, such as laboratory technique analysis, take a long time to analyse and obtain the result. Such methods also have the preferred time to keep the water sample to avoid the performance of the water sample from being affected. The pH of the water sample will become acidic if it is stored for an extended period. This phenomenon occurs because the oxygen in the water has been used up by the microorganism or bacteria. The microorganism or bacteria will die due to the lack of oxygen in the water. When the microorganism or bacteria are dead, the pH in the water will be affected and become acidic. Meanwhile, the acceptability of several inorganic constituents and chemical contaminants will be influenced by temperature, which may affect the water quality. The rise in water temperature increases the microorganism’s production. Taste, odour, colour, and corrosion issues are also affected. The ion concentrations will change with the increase or decrease in temperature, thus switching the pH value. Oxygen solubility will also decline with higher temperatures. The conductivity will also be affected by the temperature because the different ions in the water require various temperatures to activate.

Table 2
Comparison of Water Quality Parameters for Different Samples During Laboratory Testing of WQMS-LoRaWAN.

Water Quality Parameters	WQMS-LoRaWAN			Laboratory Test		
	Tap Water	Lake Water	Waste Water	Tap Water	Lake Water	Wastewater
Temp. (°C)	24.93	25.06	25.25	24.0	22.2	22.0
pH	7.12	8.09	10.98	6.69	6.85	9.34
Turbidity	0.97	9.37	11.34	1.34	10.9	13.3
TDS(mg/L)	62.39	564.76	3332.3	30	600	4500

6.3. High-Level application contexts and system integration

By outlining high-level application contexts, we aim to emphasize the adaptability and broad-reaching implications of our WQMS-LoRaWAN system. This underscores the fact that although the system was originally conceived for monitoring water quality in rural areas, its applicability extends much further.

Public Health Initiatives: Our WQMS-LoRaWAN system is designed with scalability and adaptability in mind, making it suitable for a range of high-level applications beyond rural water quality monitoring. For instance, our system can serve as an integral part of larger public health initiatives aimed at preventing waterborne diseases. Early warning signals triggered by deteriorating water quality can prompt immediate preventive actions, thereby protecting communities from outbreaks.

Emergency Response Strategies: In the event of natural disasters such as floods or industrial accidents that compromise water quality, the WQMS-LoRaWAN system can provide real-time information that is crucial for emergency response teams. This aids in making quick decisions on evacuation, distribution of water purifiers, or targeted cleaning operations.

Private Sector Applications: Water quality is not just a concern for public bodies; it’s also vital for various industries such as agriculture, brewing, and pharmaceuticals. Our system can be easily integrated into existing industrial processes for real-time water quality monitoring, helping businesses comply with regulations and optimize their operations.

Smart Cities: As urban areas continue to grow and become smarter, the integration of IoT technologies like WQMS-LoRaWAN can serve as a critical component in larger systems of water management, waste treatment, and environmental monitoring. Its low energy consumption makes it ideal for long-term deployments in such scenarios.

Potential for Integration: Given its modular design and ease of scalability, the WQMS-LoRaWAN system can be readily integrated into existing water quality monitoring infrastructures, including those that are not based on LoRaWAN technology. Its data output can be easily adapted to feed into other platforms and dashboards, thus offering flexibility and adaptability in a variety of implementation contexts.

7. Conclusion and future work

The objectives of this study have been fulfilled by proposing the use of a new LoRaWAN wireless technology for IoT applications in rural areas. A cost-effective, portable, floating, waterproof smart, and environmentally friendly WQMS-LoRaWAN system for the monitoring of water’s quality parameters in real-time has been developed and deployed at Gombang Lake to help reveal the variation of water quality in real-time and update the information to the IoT cloud (TTN, Thing-Speak, and ThingView). Four water quality sensors, namely, pH, turbidity, temperature, and TDS, have been used. The system managed to enable the communication over LoRa and LoRaWAN network to the internet to smoothly transmit the data. The system could accurately and simultaneously gather the different sensors’ real-time data, and they can be accessed via web-based/mobile-based dashboards. The system is powered using a green energy source (solar cell), which can increase system independence and energy efficiency during continuous operation. The obtained results were promising, and the developed system can improve the awareness of people and authorities about the water quality in rural areas. This system is useful for people who live in rural areas that depend on lakes or rivers as primary water resources. Individuals can track the water quality to ensure that it is safe for daily usage and free of contamination.

Our LoRaWAN-based IoT system allows for real-time monitoring of water quality, enabling rapid response to any changes or issues that may arise. The use of low-power and long-range communication technology allows our system to operate efficiently in rural areas with limited access to power and network infrastructure. The modular design of our system

makes it easy to adapt to various water monitoring needs and to incorporate additional sensors or parameters as required. On the other hand, the performance of our system may be affected by environmental factors, interference from other substances, and network connectivity challenges, as previously discussed. The initial setup and calibration of the system may require technical expertise and resources that might not be readily available in some rural areas. The reliance on batteries for power supply in remote locations may necessitate regular maintenance and battery replacement, potentially increasing the long-term operational costs of the system.

In our future work, we aim to conduct a more thorough and detailed analysis of the system's power consumption. This analysis will extend to both the active and idle states of the system, enabling us to gain a deeper understanding of its energy dynamics. By meticulously measuring and recording the energy requirements during these different operational phases, we will be able to identify areas for optimization and enhance the overall efficiency of the system. This data will be critical in refining the system's design, ensuring sustainable operation, and reducing the energy footprint, which is particularly important for deployment in resource-constrained rural areas. Our goal is to not only ensure reliable performance but also to contribute to the development of more energy-efficient IoT solutions for environmental monitoring.

Detailed statistical analysis of network performance over various operational scenarios is a part of our future development roadmap. In future iterations, we plan to conduct a more thorough analysis of network performance under different environmental conditions and settings. This will include detailed statistical analysis of packet delivery rates, signal strength variations, and the impact of different LoRaWAN parameters on overall network performance. Our commitment to enhancing and refining our WQMS-LoRaWAN system will continue, with a focus on optimizing network parameters for diverse deployment scenarios and improving the system's overall reliability and efficiency.

Recognizing the benefit of community contributions to improve and adapt our system, we will make the schematics and software open-source once we complete the project and registration process of copyright with the Intellectual Property Corporation of Malaysia (MyIPO). The complete hardware design files, sensor interface codes, and communication protocols will be accessed from the Institutional Repository (IR UMPISA). This is to encourage developers and researchers to replicate and expand upon our system and contribute to its ongoing improvement.

For the system's future enhancement, we recommend adding sensors like electrical conductivity, ORP, DO, and a GPS sensor to give a more detailed water quality assessment. Investing in higher quality, albeit pricier, sensors can refine accuracy and cater to commercialization. Streamlining electrical connections with a printed circuit board can conserve space and boost efficiency. Our system presently monitors only four water quality parameters. Expanding this with sensors detecting parameters such as Manganese, Ammonia-Nitrogen, and Nitrate-Nitrogen can offer insights into water quality classifications, which could be integrated into our GUI dashboard. Enhancing the battery life and conducting thorough research on LoRa communication metrics are essential. Integrating multiple sensing units and employing deep learning models can help in predicting rural water quality. These recommendations, combined with insights from our study, can further LoRaWAN-based IoT applications in rural areas.

For further enhancement of our system, we also suggest a focused integration of artificial intelligence (AI) and machine learning (ML) techniques. This would empower the system to understand and adapt to the nuances of water quality, building on long-term monitoring data. Collaborating with environmental specialists could allow the inclusion of a broader set of sensors, thereby broadening the scope of contamination detection. Engaging local communities might provide invaluable insights that could be used to refine the monitoring approach. The application of AI and ML can transform the system from merely recording data to forecasting potential water quality changes,

facilitating a proactive approach to interventions. As the system's reach is expanded to encompass diverse water sources, the addition of geographic information systems (GIS) can significantly enhance spatial analytics, guiding water quality improvement initiatives in specific areas. For a comprehensive understanding of water quality in rural areas, future research should adopt an interdisciplinary approach, integrating technological advances with socio-economic evaluations. Engaging with social scientists and local community leaders will be crucial to unravel the intricacies of cultural and economic influences on water quality and to devise strategies that are both technologically sound and socially attuned.

CRediT authorship contribution statement

Waheb A. Jabbar: Supervision, Funding acquisition, Project administration, Writing – original draft, Conceptualization, Methodology, Software, Validation, Investigation, Visualization, Resources, Writing – review & editing. **Tan Mei Ting:** Conceptualization, Methodology, Software, Validation. **M. Fikri I. Hamidun:** Conceptualization, Methodology, Software, Validation. **Ajwad H. Che Kamarudin:** Conceptualization, Methodology, Software, Validation. **Wenyan Wu:** Investigation, Visualization, Resources, Writing – review & editing. **Jamil Sultan:** Investigation, Visualization, Resources, Writing – review & editing. **Abdulrahman A. Alsewari:** Investigation, Visualization, Resources, Writing – review & editing. **Mohammed A.H. Ali:** Investigation, Visualization, Resources, Writing – review & editing.

Declaration of competing interest

The authors declare that they have no known competing financial interests or personal relationships that could have appeared to influence the work reported in this paper.

Data availability

No data was used for the research described in the article.

References

- Abdelfadeel, K. Q., Zorbas, D., Cionca, V., & Pesch, D. (2019). \$FREE\$—Fine-grained scheduling for reliable and energy-efficient data collection in LoRaWAN. *IEEE Internet of Things Journal*, 7(1), 669–683.
- Afsiadis, O., Cotting, M., Burg, A., & Balatsoukas-Stimming, A. (2019). On the error rate of the LoRa modulation with interference. *IEEE Transactions on Wireless Communications*, 19(2), 1292–1304.
- Almuhaya, M. A., Jabbar, W. A., Sulaiman, N., & Abdulmalek, S. (2022). A survey on LoRaWAN technology: Recent trends, opportunities, simulation tools and future directions. *Electronics*, 11(1), 164.
- Alset, U., Kulkarni, A., & Mehta, H. (2020). Performance analysis of Various LoRaWAN frequencies for optimal data transmission of water quality parameter measurement. In *2020 11th International Conference on Computing, Communication and Networking Technologies (ICCCNT)* (pp. 1–6). IEEE.
- Arduino. (2023). Arduino Uno Rev3 Retrieved 11 Nov 2023 from <https://www.arduino.cc/>.
- Beltramelli, L., Mahmood, A., Österberg, P., & Gidlund, M. (2020). LoRa beyond ALOHA: An investigation of alternative random access protocols. *IEEE Transactions on Industrial Informatics*, 17(5), 3544–3554.
- Bhardwaj, A., Dagar, V., Khan, M. O., Aggarwal, A., Alvarado, R., Kumar, M., & Proshad, R. (2022). Smart IoT and machine learning-based framework for water quality assessment and device component monitoring. *Environmental Science and Pollution Research*, 29(30), 46018–46036.
- Błażkiewicz, P., Cichoń, J., Kutylowski, M., & Zawada, M. (2019). Revised Gateway Selection for LoRa Radio Networks. In *Ad-Hoc, Mobile, and Wireless Networks: 18th International Conference on Ad-Hoc Networks and Wireless, ADHOC-NOW 2019, Luxembourg, Luxembourg, October 1–3, 2019, Proceedings 18* (pp. 228–240). Springer International Publishing.
- Boccadoro, P., Daniele, V., Di Gennaro, P., Lofù, D., & Tedeschi, P. (2022). Water quality prediction on a Sigfox-compliant IoT device: The road ahead of Waters. *Ad Hoc Networks*, 126, Article 102749.
- Caeiro, J. J., & Martins, J. C. (2021). Water management for rural environments and IoT. In *Research Anthology on Blockchain Technology in Business, Healthcare, Education, and Government* (pp. 246–262). IGI Global.

- Chaudhari, B. S., Zennaro, M., & Borkar, S. (2020). LPWAN Technologies: Emerging Application Characteristics, Requirements, and Design Considerations. *Future Internet*, 12(3), 46.
- Chen, Y., & Han, D. (2018). Water quality monitoring in smart city: A pilot project. *Automation in Construction*, 89, 307–316.
- Cloete, N. A., Malekian, R., & Nair, L. (2016). Design of smart sensors for real-time water quality monitoring. *IEEE Access*, 4, 3975–3990.
- Croce, D., Gucciardo, M., Mangione, S., Santaromita, G., & Tinnirello, I. (2019). LoRa technology demystified: From link behavior to cell-level performance. *IEEE Transactions on Wireless Communications*, 19(2), 822–834.
- Cytron. (2021). *Cytron LoRa-RFM Shield*. Retrieved 12 Nov 2023 from <https://www.cytron.io/p-cytron-lora-rfm-shield>.
- Cytron. (2020). 2020 PCB Connector Housing 2 Ways. Retrieved 12 Nov 2023 from <https://www.cytron.io/p-2020-pcb-connector-housing-2-ways>.
- Cytron.IO. (2022). *915MHz LoRa Gateway Raspberry Pi Hat*. Retrieved 12 Nov 2023 from <https://www.cytron.io/p-915mhz-lora-gateway-raspberry-pi-hat>.
- Das, B., & Jain, P. C. (2017). Real-time water quality monitoring system using Internet of Things. In *2017 International conference on computer, communications and electronics (Comtelix)* (pp. 78–82). IEEE.
- Faber, M. J., van der Zwaag, K. M., dos Santos, W. G. V., Rocha, H. R., & d. O., Segatto, M. E., & Silva, J. A. (2020). A theoretical and experimental evaluation on the performance of LoRa technology. *IEEE Sensors Journal*, 20(16), 9480–9489.
- Fathoni, H., Miao, H. Y., Chen, C. Y., & Yang, C. T. (2020). A monitoring system of water quality Tunghai Lake using LoRaWAN. In *2020 International Conference on Pervasive Artificial Intelligence (ICPAI)* (pp. 281–283). IEEE.
- Feisal, N. A. S., Kamaludin, N. H., Sani, M. F. A., Ahmad, D. K. A., Ahmad, M. A., Razak, N. F. A., & Ibrahim, T. N. B. T. (2023). *Anthropogenic disturbance of aquatic biodiversity and water quality of an urban river in Penang* (p. 2023). Malaysia: Water Science and Engineering, In Pres.
- Goundar, S. S., Pillai, M. R., Mamun, K. A., Islam, F. R., & Deo, R. (2015). Real time condition monitoring system for industrial motors. In *2015 2nd Asia-Pacific World Congress on Computer Science and Engineering (APWC on CSE)* (pp. 1–9). IEEE.
- Ighalo, J. O., Adeniyi, A. G., & Marques, G. (2020). Internet of things for water quality monitoring and assessment: A comprehensive review. *Artificial intelligence for sustainable development: Theory, practice and future applications*, 245–259.
- Jabbar, W. A., Annathurai, S., Rahim, T. A. A., & Fauzi, M. F. M. (2022). Smart energy meter based on a long-range wide-area network for a stand-alone photovoltaic system. *Expert Systems with Applications*, 197, Article 116703.
- Jáquez, A. D. B., Herrera, M. T. A., Celestino, A. E. M., Ramírez, E. N., & Cruz, D. A. M. (2023). Extension of LoRa Coverage and Integration of an Unsupervised Anomaly Detection Algorithm in an IoT Water Quality Monitoring System. *Water*, 15(7), 1351.
- Jiao, D. L., & Luo, X. (2018). Water quality monitoring system based on LoRa. *DEStech Trans. Comput. Sci. Eng.* 10, 1107–1116.
- Kuo, Y.-W., Li, C.-L., Jhang, J.-H., & Lin, S. (2018). Design of a wireless sensor network-based IoT platform for wide area and heterogeneous applications. *IEEE Sensors Journal*, 18(12), 5187–5197.
- Lap, B. Q., Du Nguyen, H., Hang, P. T., Phi, N. Q., Hoang, V. T., Linh, P. G., & Hang, B. T. T. (2023). Predicting Water Quality Index (WQI) by feature selection and machine learning: A case study of An Kim Hai irrigation system. *Ecological Informatics*, 101991.
- Li, L. Y., Jaafar, H., & Ramli, N. H. (2018). Preliminary study of water quality monitoring based on WSN technology. In *2018 International Conference on Computational Approach in Smart Systems Design and Applications (ICASSDA)* (pp. 1–7). IEEE.
- Li, Y., Yan, X., Zeng, L., & Wu, H. (2017). Research on water meter reading system based on LoRa communication. *2017 IEEE International Conference on Smart Grid and Smart Cities (ICSGSC)*.
- Liu, Y. T., Lin, B. Y., Yue, X. F., Cai, Z. X., Yang, Z. X., Liu, W. H., & Chen, J. Y. (2018). A solar powered long range real-time water quality monitoring system by LoRaWAN. In *2018 27th Wireless and Optical Communication Conference (WOCC)* (pp. 1–2). IEEE.
- Magrin, D., Capuzzo, M., & Zanella, A. (2019). A thorough study of LoRaWAN performance under different parameter settings. *IEEE Internet of Things Journal*, 7(1), 116–127.
- Mroue, H., Parrein, B., Hamrioui, S., Bakowski, P., Nasser, A., Cruz, E. M., & Vince, W. (2020). LoRa+: An extension of LoRaWAN protocol to reduce infrastructure costs by improving the Quality of Service. *Internet of Things*, 9, Article 100176.
- Myint, C. Z., Gopal, L., & Aung, Y. L. (2017). Reconfigurable smart water quality monitoring system in IoT environment. In *2017 IEEE/ACIS 16th international conference on computer and information science (ICIS)* (pp. 435–440). IEEE.
- Ngom, B., Diallo, M., Gueye, B., & Marilleau, N. (2019). In *March*. *LoRa-based measurement station for water quality monitoring: case of botanical garden pool* (pp. 1–4). IEEE.
- Olatinwo, S. O., & Joubert, T.-H. (2018). Energy efficient solutions in wireless sensor systems for water quality monitoring: A review. *IEEE Sensors Journal*, 19(5), 1596–1625.
- Osman, S. O., Mohamed, M. Z., Suliman, A. M., & Mohammed, A. A. (2018, August). Design and implementation of a low-cost real-time in-situ drinking water quality monitoring system using arduino. In *2018 International Conference on Computer, Control, Electrical, and Electronics Engineering (ICCCCEE)* (pp. 1–7). IEEE.
- Perumal, T., Sulaiman, M. N., & Leong, C. Y. (2015). Internet of Things (IoT) enabled water monitoring system. In *2015 IEEE 4th Global Conference on Consumer Electronics (GCCE)* (pp. 86–87). IEEE.
- Pi, R. (2020). *Raspberry Pi 3 Model B+*. Retrieved 12 Nov 2023 from <https://www.raspberrypi.com/products/raspberry-pi-3-model-b-plus/>.
- Prasad, A. N., Mamun, K. A., Islam, F. R., & Haqva, H. (2015). Smart water quality monitoring system. In *2015 2nd Asia-Pacific World Congress on Computer Science and Engineering (APWC on CSE)* (pp. 1–6). IEEE.
- Premasankar, G., Ghaddar, B., Slabicki, M., & Di Francesco, M. (2020). Optimal configuration of LoRa networks in smart cities. *IEEE Transactions on Industrial Informatics*, 16(12), 7243–7254.
- Qin, Y., Alam, A. U., Pan, S., Howlader, M. M., Ghosh, R., Hu, N.-X., & Deen, M. J. (2018). Integrated water quality monitoring system with pH, free chlorine, and temperature sensors. *Sensors and Actuators B: Chemical*, 255, 781–790.
- Ragnoli, M., Barile, G., Leoni, A., Ferri, G., & Stornelli, V. (2020). An autonomous low-power LoRa-based flood-monitoring system. *Journal of Low Power Electronics and Applications*, 10(2), 15.
- Raut, V., & Shelke, S. (2016, June). Wireless acquisition system for water quality monitoring. In *2016 Conference on Advances in signal Processing (CASP)* (pp. 371–374). IEEE.
- Reynders, B., Wang, Q., & Pollin, S. (2018, June). A LoRaWAN module for ns-3: Implementation and evaluation. In *Proceedings of the 2018 Workshop on ns-3* (pp. 61–68).
- Saravanan, M., Das, A., & Iyer, V. (2017). Smart water grid management using LPWAN IoT technology. In *2017 Global Internet of Things Summit (GIoTS)* (pp. 1–6). IEEE.
- Schneider, T., Helwig, N., & Schütze, A. (2018). Industrial condition monitoring with smart sensors using automated feature extraction and selection. *Measurement Science and Technology*, 29(9), Article 094002.
- Seedstudio. (2021). *Solar Charger Shield V2.2*. Retrieved 12 Nov 2023 from https://wiki.seedstudio.com/Solar_Charger_Shield_V2.2/.
- Sherazi, H. H. R., Grieco, L. A., Imran, M. A., & Boggia, G. (2020). Energy-efficient LoRaWAN for industry 4.0 applications. *IEEE Transactions on Industrial Informatics*, 17(2), 891–902.
- Shirode, M., Adaling, M., Biradar, J., & Mate, T. (2018). IOT Based Water Quality Monitoring System. *International Journal of Scientific Research in Computer Science, Engineering and Information Technology*, 3(1), 1423–1428.
- Short, M., & Twiddle, J. (2019). An industrial digitalization platform for condition monitoring and predictive maintenance of pumping equipment. *Sensors*, 19(17), 3781.
- Singh, R. K., Aernouts, M., De Meyer, M., Weyn, M., & Berkvens, R. (2020). Leveraging LoRaWAN Technology for Precision Agriculture in Greenhouses. *Sensors*, 20(7), 1827.
- Tolentino, L. K., Añover, J. R., Cabrera, C., Chua, E. J., Hizon, C. A., Mallari, J. G., & Fernandez, E. (2020). IoT-Based Automated Water Monitoring and Correcting Modular Device Through LoRaWAN for Aquaculture. *International Journal of Computing and Digital Systems*, 9, 1–14.
- Tolentino, L. K., Chua, E. J., Añover, J. R., Cabrera, C., Hizon, C. A., Mallari, J. G., & Madrigal, G. A. (2021). IoT-Based Automated Water Monitoring and Correcting Modular Device via LoRaWAN for Aquaculture. *International Journal of Computing and Digital Systems*, 10, 533–544.
- Vijayakumar, N., & Ramya, A. R. (2015). The real time monitoring of water quality in IoT environment. In *2015 International Conference on Innovations in Information, Embedded and Communication Systems (ICIIECS)* (pp. 1–5). IEEE.
- Wang, G., Nixon, M., & Boudreaux, M. (2019). Toward cloud-assisted industrial IoT platform for large-scale continuous condition monitoring. *Proceedings of the IEEE*, 107(6), 1193–1205.
- Wu, N., & Khan, M. (2019). LoRa-based internet-of-things: a water quality monitoring system. In *2019 SoutheastCon* (pp. 1–4). IEEE.
- Zakaria, M. I., Jabbar, W. A., & Sulaiman, N. (2023). Development of a smart sensing unit for LoRaWAN-based IoT flood monitoring and warning system in catchment areas. *Internet of Things and Cyber-Physical Systems*, 3, 249–261.
- Zhang, Y.-F., & Thorburn, P. J. (2022). A deep surrogate model with spatio-temporal awareness for water quality sensor measurement. *Expert Systems with Applications*, 200, Article 116914.
- Zhao, Z., Zhou, Y., Wang, X., Wang, Z., & Bai, Y. (2022). Water quality evolution mechanism modeling and health risk assessment based on stochastic hybrid dynamic systems. *Expert Systems with Applications*, 116404.